

Aroid
CONTRACT • CONTRAT
A GROUPE LACASSE BRAND



Price List
Effective January 2015

Table of Contents

About Arold / How to Use this Price List / What about special products?	3
Seating collections	4-52
Accessories	53
C.O.M./C.O.V. Policy	54
Custom Fabric Form	55
Terms and Conditions	56-57
Warranty	58
Lacasse thermofused laminate finishes / Arold wood finishes / Sample Order	59

Quick Reference Index

Series	Series Abbrev.	Modular	Lounge	Public Areas	Healthcare	Page
Aerial	AE			•	•	4-5
Apéro	AP		•			6
Barolo	BA		•			7
Bourbon	BB		•			8
Churchill	CH		•			9
Cube 100	CU1		•	•		10-11
Cube 200	CU2	•	•	•		12-15
Cube 300	CU3	•	•	•		16-19
Florence	FL		•			20
Hip Hop	H	•	•	•		21-34
Hip Hop Junior	HJ	•	•	•		34-36
Lincoln	LC		•			37
Martini	MA		•			38
Napa	NA		•			39
Oly	LY		•			40
Pouf	PF		•			41-42
Soho	SH		•			43
Sonoma	SO		•			44
Terra	TE			•	•	45-48
Zeta	ZE			•		49-52

Important note: Any artistic, photographic, clerical, typographical and pricing errors and omissions in this price list are subject to correction. Prices and product specifications are subject to change without notice.

www.groupelacasse.com

ABOUT AROLD...

Arold is synonym of quality, craftsmanship and endless possibilities.

Great expertise and experience have been put together to develop products that will fit your needs and ignite the designer in you. No matter the space you are creating, may it be large or small, for public areas or healthcare facilities, Arold has the product you need.

We look forward to assist you with any questions and support your efforts to make Arold a prized brand under our already successful family of products.

Take a seat and feel the Arold difference.

WHAT ABOUT SPECIAL PRODUCTS?

Groupe Lacasse stands out for its unwavering commitment to flexibility and Arold is no exception. We can help you with non-standard seating solutions to your specific environment, your special needs and your budget. Please contact **Groupe Lacasse Quotations Department** for an assessment of your request.

HOW TO USE THIS PRICE LIST

Find the products you need

Refer to the **Table of Contents** to find the solutions you require.

Pictures of various models are available on the Groupe Lacasse website (www.groupelacasse.com).

Specify the upholstery and finishes you want

Once you've selected the products that meet your needs, refer to the appropriate upholstery and finish document that can be found in the login section of the website and make a note of the applicable codes.

Refer to the **Sample Order** sections specific to each model to ensure integrity of order.

Submit your order

Fax: Groupe Lacasse Inc.
Attn: Order Entry
1-800-363-5474

Email: oc@groupelacasse.com

Contact us if you have questions

Making sure you get what you need – on time and accurately – is our first priority. Should you ever have questions, please feel free to contact our Customer Service department.

Telephone: 1-888-522-2773
Email: customerservice@groupelacasse.com



HEALTHCARE AND PUBLIC AREAS

SPECIFICATIONS

- All models ship assembled.
- Fabric/fabric, fabric/vinyl and vinyl/vinyl dual upholstery is available. The first upholstery code is the backrest and a seat cushion, the second upholstery code is for the arms and outer back. As for the 3-seat ottoman, the first upholstery code is for the ottomans at the extremities, the second upholstery code is for the middle ottoman.
- If dual upholstery combination is from two different grades, list price is the highest grade of the two.
- 1 ½" gap around seat cushion for ease of cleaning.
- 16-gauge steel base and belt.
- Levelers allow up to 1" height adjustment.
- Please refer to accessories on page 53 for ganging brackets and floor anchors.
- C.O.M./C.O.V.: please refer to page 54.

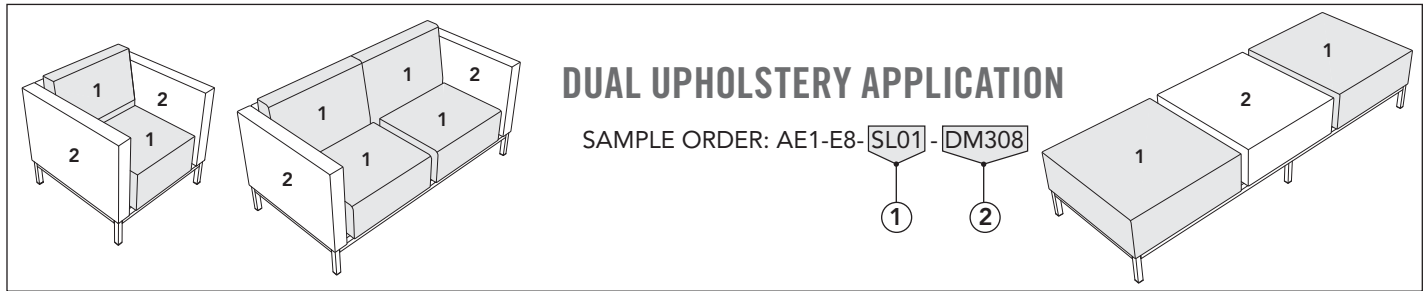

SAMPLE ORDER: AE1-E8-SL01-DM308

AE1

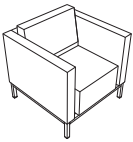

Description	Dimensions	(in)	(mm)	Dimensions	(in)	(mm)
Armchair	Seat width	23 ½	597	Overall width	30 ½	775
	Seat depth	21	533	Overall depth	30 ½	775
	Seat height	18	457	Overall height	31	787
	Back height	13 ½	343			

Model	Frame	Upholstery / List (\$)
AE1	E8 Std	Grade 1 1,564
		Grade 2 1,589
	E9 N/C	Grade 3 1,620
		Grade 4 1,651
		Grade 5 1,682
		Grade 6 1,714
		Grade 7 2,716
		Grade 8 1,776

AE2

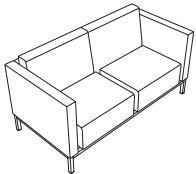

Description	Dimensions	(in)	(mm)	Dimensions	(in)	(mm)
Loveseat	Seat width	54	1372	Overall width	61	1549
	Seat depth	21	533	Overall depth	30 ½	775
	Seat height	18	457	Overall height	31	787
	Back height	13 ½	343			

Model	Frame	Upholstery / List (\$)
AE2	E8 Std	Grade 1 2,595
		Grade 2 2,638
	E9 N/C	Grade 3 2,692
		Grade 4 2,746
		Grade 5 2,800
		Grade 6 2,854
		Grade 7 4,571
		Grade 8 2,961

AE3

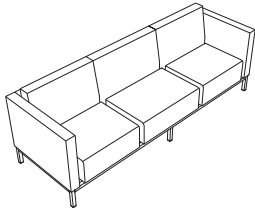

Description	Dimensions	(in)	(mm)	Dimensions	(in)	(mm)
Sofa	Seat width	84 ½	2146	Overall width	91 ½	2324
	Seat depth	21	533	Overall depth	30 ½	775
	Seat height	18	457	Overall height	31	787
	Back height	13 ½	343			

Model	Frame	Upholstery / List (\$)	
AE3	E8 Std	Grade 1	3,596
		Grade 2	3,658
	E9 N/C	Grade 3	3,735
		Grade 4	3,811
		Grade 5	3,888
		Grade 6	3,965
		Grade 7	6,428
		Grade 8	4,119

AE01

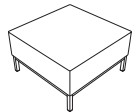

Description	Dimensions	(in)	(mm)
1-seat ottoman	Overall width	30 ½	775
	Overall depth	30 ½	775
	Overall height	18	457

Model	Frame	Upholstery / List (\$)	
AE01	E8 Std	Grade 1	951
		Grade 2	961
	E9 N/C	Grade 3	973
		Grade 4	986
		Grade 5	998
		Grade 6	1,011
		Grade 7	1,499
		Grade 8	1,036

AE02

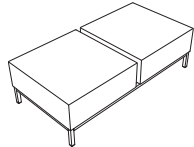

Description	Dimensions	(in)	(mm)
2-seat ottoman	Overall width	61	1549
	Overall depth	30 ½	775
	Overall height	18	457

Model	Frame	Upholstery / List (\$)	
AE02	E8 Std	Grade 1	1,676
		Grade 2	1,696
	E9 N/C	Grade 3	1,721
		Grade 4	1,746
		Grade 5	1,771
		Grade 6	1,796
		Grade 7	2,774
		Grade 8	1,846

AE03

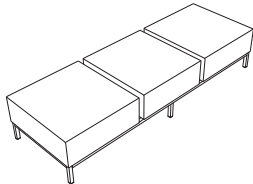

Description	Dimensions	(in)	(mm)
3-seat ottoman	Overall width	91 ½	2324
	Overall depth	30 ½	775
	Overall height	18	457

Model	Frame	Upholstery / List (\$)	
AE03	E8 Std	Grade 1	2,283
		Grade 2	2,313
	E9 N/C	Grade 3	2,350
		Grade 4	2,388
		Grade 5	2,425
		Grade 6	2,463
		Grade 7	3,929
		Grade 8	2,538

LOUNGE

SPECIFICATIONS

- All models ship assembled.
- Fabric/fabric, fabric/vinyl and vinyl/vinyl dual upholstery is available. The first upholstery code is the backrest and arms, the second upholstery code is for the seat.
- If dual upholstery combination is from two different grades, list price is the highest grade of the two.
- 4 ½" height metal legs in aluminum finish.
- C.O.M./C.O.V.: please refer to page 54.

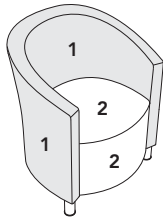

DUAL UPHOLSTERY APPLICATION

SAMPLE ORDER: AP1-ML-SL01-DM308

1

2

SAMPLE ORDER: AP1-ML-SL01-DM308

AP1

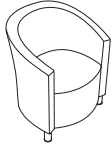

Description	Dimensions	(in)	(mm)	Dimensions	(in)	(mm)
Armchair	Seat width	21 ½	546	Overall width	28	711
Aluminum legs	Seat depth	20	508	Overall depth	26 ½	673
	Seat height	18 ½	470	Overall height	32	813
	Back height	13 ½	343			

Model	Frame	Upholstery / List (\$)
AP1	ML Std	Grade 1 1,520
		Grade 2 1,540
		Grade 3 1,565
		Grade 4 1,590
		Grade 5 1,615
		Grade 6 1,640
		Grade 7 2,178
		Grade 8 1,690

AP1SB



Description	Dimensions	(in)	(mm)	Dimensions	(in)	(mm)
Chair	Seat width	21 ½	546	Overall width	24	610
Aluminum legs	Seat depth	20	508	Overall depth	26 ½	673
	Seat height	18 ½	470	Overall height	32	813
	Back height	13 ½	343			

Model	Frame	Upholstery / List (\$)
AP1SB	ML Std	Grade 1 1,245
		Grade 2 1,262
		Grade 3 1,284
		Grade 4 1,306
		Grade 5 1,328
		Grade 6 1,350
		Grade 7 1,738
		Grade 8 1,393

LOUNGE

SPECIFICATIONS

- Ships assembled.
- Fabric/fabric, fabric/vinyl and vinyl/vinyl dual upholstery is available. The first upholstery code is the backrest and arms, the second upholstery code is for the seat.
- If dual upholstery combination is from two different grades, list price is the highest grade of the two.
- C.O.M./C.O.V.: please refer to page 54.

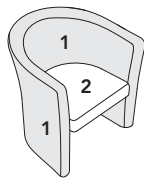

DUAL UPHOLSTERY APPLICATION

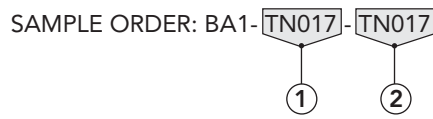

SAMPLE ORDER: BA1-TN017-TN017

BA1

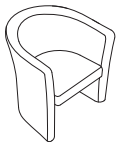

Description	Dimensions	(in)	(mm)	Dimensions	(in)	(mm)
Armchair	Seat width	19 ½	495	Overall width	30 ½	775
Integrated lumbar support	Seat depth	19 ½	495	Overall depth	31	788
	Seat height	17 ½	445	Overall height	31 ¾	807
	Back height	14 ¼	362			

Model	Upholstery / List (\$)
BA1	Grade 1 1,357
	Grade 2 1,377
	Grade 3 1,402
	Grade 4 1,427
	Grade 5 1,452
	Grade 6 1,477
	Grade 7 2,279
	Grade 8 1,527

LOUNGE

SPECIFICATIONS

- All models ship assembled.
- Available in one tone only.

- C.O.M./C.O.V.: please refer to page 54.

SAMPLE ORDER: BB2-ML-OL04

BB1

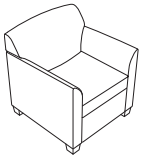

Description	Dimensions	(in)	(mm)	Dimensions	(in)	(mm)
Armchair	Seat width	21	533	Overall width	29 ½	749
Aluminum legs	Seat depth	21 ½	546	Overall depth	32 ½	826
	Seat height	17 ¼	438	Overall height	33 ¼	845
	Back height	16	432			

Model	Frame	Upholstery / List (\$)
BB1	ML Std	Grade 1 1,864
		Grade 2 1,894
		Grade 3 1,931
		Grade 4 1,969
		Grade 5 2,006
		Grade 6 2,044
		Grade 7 3,104
		Grade 8 2,119

BB2

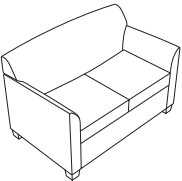

Description	Dimensions	(in)	(mm)	Dimensions	(in)	(mm)
Loveseat	Seat width	43	1092	Overall width	51	1295
Aluminum legs	Seat depth	21 ½	546	Overall depth	32 ½	826
	Seat height	17 ¼	438	Overall height	33 ¼	845
	Back height	16	432			

Model	Frame	Upholstery / List (\$)
BB2	ML Std	Grade 1 2,427
		Grade 2 2,464
		Grade 3 2,511
		Grade 4 2,558
		Grade 5 2,605
		Grade 6 2,652
		Grade 7 3,985
		Grade 8 2,746

BB3

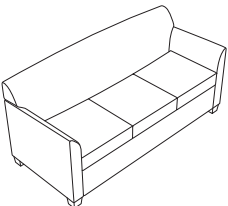

Description	Dimensions	(in)	(mm)	Dimensions	(in)	(mm)
Sofa	Seat width	64 ½	1638	Overall width	72 ½	1842
Aluminum legs	Seat depth	21 ½	546	Overall depth	32 ½	826
	Seat height	17 ¼	438	Overall height	33 ¼	845
	Back height	16	432			

Model	Frame	Upholstery / List (\$)
BB3	ML Std	Grade 1 2,921
		Grade 2 2,976
		Grade 3 3,044
		Grade 4 3,113
		Grade 5 3,182
		Grade 6 3,251
		Grade 7 5,204
		Grade 8 3,388

LOUNGE

SPECIFICATIONS

- All models ship assembled.
- Available in one tone only.
- Refer to page 59 for the 4 wood leg finishes available.
- C.O.M./C.O.V.: please refer to page 54.

SAMPLE ORDER: CH3-W1-CY07

CH1



Description	Dimensions	(in)	(mm)	Dimensions	(in)	(mm)
Armchair Wooden legs	Seat width	21	533	Overall width	35	889
	Seat depth	21	533	Overall depth	33	832
	Seat height	17	432	Overall height	34	864
	Back height	17	432			

Model	Frame	Upholstery / List (\$)	
CH1	W1 Std	Grade 1	1,907
		Grade 2	1,937
	W2 N/C	Grade 3	1,975
		Grade 4	2,013
	W3 N/C	Grade 5	2,050
		Grade 6	2,088
	W4 N/C	Grade 7	3,148
		Grade 8	2,163

CH2

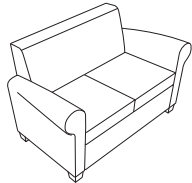

Description	Dimensions	(in)	(mm)	Dimensions	(in)	(mm)
Loveseat Wooden legs	Seat width	45	1143	Overall width	59	1449
	Seat depth	21	533	Overall depth	33	832
	Seat height	17	432	Overall height	34	864
	Back height	17	432			

Model	Frame	Upholstery / List (\$)	
CH2	W1 Std	Grade 1	2,495
		Grade 2	2,535
	W2 N/C	Grade 3	2,585
		Grade 4	2,635
	W3 N/C	Grade 5	2,685
		Grade 6	2,735
	W4 N/C	Grade 7	4,153
		Grade 8	2,836

CH3

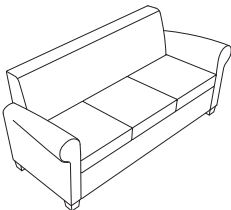

Description	Dimensions	(in)	(mm)	Dimensions	(in)	(mm)
Sofa Wooden legs	Seat width	68	1727	Overall width	82	2083
	Seat depth	21	533	Overall depth	33	832
	Seat height	17	432	Overall height	34	864
	Back height	17	432			

Model	Frame	Upholstery / List (\$)	
CH3	W1 Std	Grade 1	2,996
		Grade 2	3,051
	W2 N/C	Grade 3	3,119
		Grade 4	3,188
	W3 N/C	Grade 5	3,257
		Grade 6	3,326
	W4 N/C	Grade 7	5,279
		Grade 8	3,463

LOUNGE AND PUBLIC AREAS

SPECIFICATIONS

- All models ship assembled.
- Fabric/fabric, fabric/vinyl and vinyl/vinyl dual upholstery is available. The first upholstery code is the backrest and a seat cushion, the second upholstery code is for the arms and structure.
- If dual upholstery combination is from two different grades, list price is the highest grade of the two.
- Higher back optional feature adds 3" to the back cushion only.
- Tablet arm cannot be retrofitted on existing model.
- If optional electrical module is selected, the module will be located in left side of the front structure.
- 14-gauge steel belt with 16-gauge steel legs.
- 3" soft dual wheel casters are available on the armchair only.
- Levelers allow up to 1 ½" height adjustment.
- Please refer to your Lacasse Sampler for laminate choices.
- Please refer to accessories on page 53 for ganging brackets and floor anchors.
- C.O.M./C.O.V.: please refer to page 54.

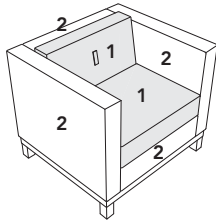

DUAL UPHOLSTERY APPLICATION

SAMPLE ORDER: CU110-E9-TN609-TN609-SA-TAL-TWT-DH



SAMPLE ORDER: CU110-E9-TN609-TN609-SA-TAL-TWT-DH

CU110

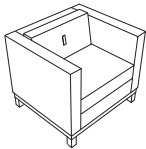

Description	Dimensions	(in)	(mm)	Dimensions	(in)	(mm)
Armchair	Seat width	24	609	Overall width	32 ¾	832
Metal base included	Seat depth	18 ½	470	Overall depth	29 ½	750
	Seat height	17 ¼	438	Overall height	28	712
	Back height	10 ¾	273			

Model	Frame	Upholstery / List (\$)	Button (\$)	Tablet arm (\$)	Tablet finis	Other options (\$)
CU110	E8 Std	Grade 1 1,526	A Std	NA Std	NA Std	DH 50
	E9 N/C	Grade 2 1,556	SA N/C	TAL 407	Specify laminate code	PC (1x) 600
		Grade 3 1,594		TAR 407		SDW 85
		Grade 4 1,631				CSB 50
		Grade 5 1,669				CSW 50
		Grade 6 1,706				
		Grade 7 2,514				
		Grade 8 1,781				

CU120

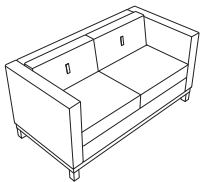

Description	Dimensions	(in)	(mm)	Dimensions	(in)	(mm)
Loveseat	Seat width	48	1219	Overall width	56 ½	1535
Metal base included	Seat depth	18 ½	470	Overall depth	29 ½	750
	Seat height	17 ¼	438	Overall height	28	712
	Back height	10 ¾	273			

Model	Frame	Upholstery / List (\$)	Button (\$)	Tablet arm (\$)	Tablet finis	Other options (\$)
CU120	E8 Std	Grade 1 2,301	A Std	NA Std	NA Std	DH 100
	E9 N/C	Grade 2 2,352	SA N/C	TAL 407	Specify laminate code	PC (1x) 600
		Grade 3 2,414		TAR 407		CSB 100
		Grade 4 2,477				CSW 100
		Grade 5 2,539				
		Grade 6 2,602				
		Grade 7 3,673				
		Grade 8 2,727				

CU130

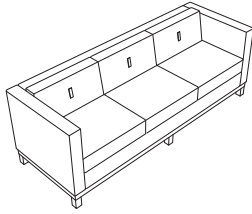

Description	Dimensions (in)		Dimensions (mm)			
Sofa	Seat width	71 ½	1816	Overall width	79 ½	2019
Metal base included	Seat depth	18 ½	470	Overall depth	29 ½	750
	Seat height	17 ¼	438	Overall height	28	712
	Back height	10 ¾	273			

Model	Frame	Upholstery / List (\$)	Button (\$)	Tablet arm (\$)	Tablet finis	Other options (\$)
CU130	E8 Std	Grade 1 2,883	A Std	NA Std	NA Std	DH 150
	E9 N/C	Grade 2 2,943	SA N/C	TAL 407	Specify laminate code	PC (1x) 600
		Grade 3 3,018		TAR 407		CSB 150
		Grade 4 3,093				CSW 150
		Grade 5 3,168				
		Grade 6 3,243				
		Grade 7 4,936				
		Grade 8 3,393				

MODULAR, LOUNGE, AND PUBLIC AREAS

SPECIFICATIONS

- Storage units and tables ship assembled. Minimum assembly is required to mount units to the base.
- Fabric/fabric, fabric/vinyl and vinyl/vinyl dual upholstery is available. The first upholstery code is the backrest and a seat cushion, the second upholstery code is for the arms and structure. As for the ottoman, the first upholstery code is seat cushion, the second upholstery code is for the under structure.
- If dual upholstery combination is from two different grades, list price is the highest grade of the two.
- Higher back optional feature adds 3" to the back cushion only.
- Tablet arm cannot be retrofitted on existing model.
- If optional electrical module is selected, the module will be located in the left side of the front structure.
- 14-gauge steel belt with 16-gauge steel legs.
- 3" soft dual wheel casters are available on the armchair only.
- Levelers allow up to 1 ½" height adjustment.
- Please refer to your Lacasse Sampler for laminate choices.
- Please refer to accessories on page 53 for ganging brackets and floor anchors.
- C.O.M./C.O.V.: please refer to page 54.
- Units from this series were tested and successfully met ANSI/BIFMA X5.4-2012 standards.

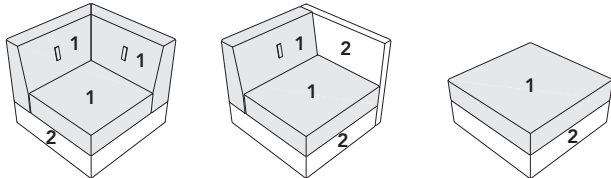

DUAL UPHOLSTERY APPLICATION

SAMPLE ORDER: CU201-CS009-CS009-PC

1

2

SAMPLE ORDER: CU201-CS009-CS009-PC

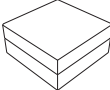
	Description	Dimensions	(in)	(mm)	Dimensions	(in)	(mm)
CU201 	Ottoman	Seat width	24 ½	622	Overall width	24 ½	622
		Seat depth	24 ½	622	Overall depth	24 ½	622
		Seat height	17 ¼	438	Overall height	17 ¼	438
Model	Upholstery / List (\$)	Other options (\$)					
CU201	Grade 1 469	PC (1x)	600				
	Grade 2 478	CSB	50				
	Grade 3 489	CSW	50				
	Grade 4 500						
	Grade 5 511						
	Grade 6 522						
	Grade 7 820						
	Grade 8 543						

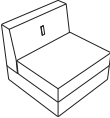
	Description	Dimensions	(in)	(mm)	Dimensions	(in)	(mm)
CU202 	Armless chair	Seat width	24 ½	622	Overall width	24 ½	622
		Seat depth	18 ½	470	Overall depth	24 ½	622
		Seat height	17 ¼	438	Overall height	28	712
		Back height	10 ¾	273			
Model	Upholstery / List (\$)	Button (\$)		Other options (\$)			
CU202	Grade 1 775	A	Std	DH	50		
	Grade 2 789	SA	N/C	CSB	50		
	Grade 3 806			CSW	50		
	Grade 4 824			PC (1x)	600		
	Grade 5 841						
	Grade 6 858						
	Grade 7 1,412						
	Grade 8 892						

CU203

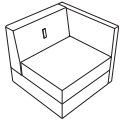

Description	Dimensions (in)	(mm)	Dimensions (in)	(mm)		
Left-side armchair	Seat width	22	558	Overall width	24 ½	622
	Seat depth	18 ½	470	Overall depth	24 ½	622
	Seat height	17 ¼	438	Overall height	28	712
	Back height	10 ¾	273			

Model	Upholstery / List (\$)	Button (\$)	Tablet arm (\$)	Tablet finis	Other options (\$)	
CU203	Grade 1	901	A Std	NA Std	NA Std	DH 50
	Grade 2	917	SA N/C	TAL 407	Specify laminate code	CSB 50
	Grade 3	938				CSW 50
	Grade 4	958				PC (1x) 600
	Grade 5	979				
	Grade 6	1,000				
	Grade 7	1,537				
	Grade 8	1,041				

CU204

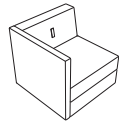

Description	Dimensions (in)	(mm)	Dimensions (in)	(mm)		
Right-side armchair	Seat width	22	712	Overall width	24 ½	622
	Seat depth	18 ½	470	Overall depth	24 ½	622
	Seat height	17 ¼	438	Overall height	28	712
	Back height	10 ¾	273			

Model	Upholstery / List (\$)	Button (\$)	Tablet arm (\$)	Tablet finis	Other options (\$)	
CU204	Grade 1	901	A Std	NA Std	NA Std	DH 50
	Grade 2	917	SA N/C	TAR 407	Specify laminate code	CSB 50
	Grade 3	938				CSW 50
	Grade 4	958				PC (1x) 600
	Grade 5	979				
	Grade 6	1,000				
	Grade 7	1,537				
	Grade 8	1,041				

CU205

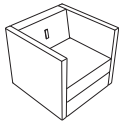

Description	Dimensions (in)	(mm)	Dimensions (in)	(mm)		
Armchair	Seat width	18	457	Overall width	24 ½	622
	Seat depth	18 ½	470	Overall depth	24 ½	622
	Seat height	17 ¼	438	Overall height	28	712
	Back height	10 ¾	273			

Model	Upholstery / List (\$)	Button (\$)	Tablet arm (\$)	Tablet finis	Other options (\$)	
CU205	Grade 1	1,007	A Std	NA Std	NA Std	DH 50
	Grade 2	1,029	SA N/C	TAL 407	Specify laminate code	CSB 50
	Grade 3	1,058		TAR 407		CSW 50
	Grade 4	1,086				PC (1x) 600
	Grade 5	1,114				
	Grade 6	1,142				
	Grade 7	1,808				
	Grade 8	1,198				

CU206

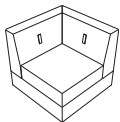

Description	Dimensions (in)	(mm)	Dimensions (in)	(mm)		
Corner armchair	Seat width	18 ½	470	Overall width	24 ½	622
	Seat depth	18 ½	470	Overall depth	24 ½	622
	Seat height	17 ¼	438	Overall height	28	712
	Back height	10 ¾	273			

Model	Upholstery / List (\$)	Button (\$)	Other options (\$)
CU206	Grade 1	1,051	A Std DH 100
	Grade 2	1,067	SA N/C CSB 50
	Grade 3	1,088	CSW 50
	Grade 4	1,108	
	Grade 5	1,129	
	Grade 6	1,150	
	Grade 7	1,687	
	Grade 8	1,191	

CU2-TS

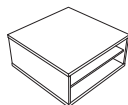

Description	Dimensions	(in)	(mm)
Single access storage unit Metal base not included	Overall width	24 ½	622
	Overall depth	24 ½	622
	Overall height	17 ¼	438

Model	List (\$)	Laminate finis
CU2-TS	475	Specify code

CU2-TD

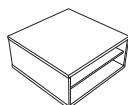

Description	Dimensions	(in)	(mm)
Double access storage unit Metal base not included	Overall width	24 ½	622
	Overall depth	24 ½	622
	Overall height	17 ¼	438

Model	List (\$)	Laminate finis
CU2-TD	507	Specify code

CU2-TSP

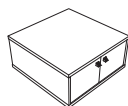

Description	Dimensions	(in)	(mm)
Single access storage unit with doors Metal base not included	Overall width	24 ½	622
	Overall depth	24 ½	622
	Overall height	17 ¼	438

Model	List (\$)	Laminate finis
CU2-TSP	594	Specify code

CU2-TDP

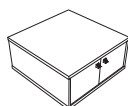

Description	Dimensions	(in)	(mm)
Double access storage unit with doors Metal base not included	Overall width	24 ½	622
	Overall depth	24 ½	622
	Overall height	17 ¼	438

Model	List (\$)	Laminate finis
CU2-TDP	688	Specify code

CU2-TF

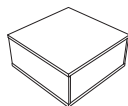

Description	Dimensions	(in)	(mm)
Closed unit Metal base not included	Overall width	24 ½	622
	Overall depth	24 ½	622
	Overall height	17 ¼	438

Model	List (\$)	Laminate finis
CU2-TF	488	Specify code

CU2B1M

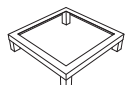

Description	Dimensions	(in)	(mm)
Single-section metal base Hardware included	Overall width	23 ¾	603
	Overall depth	23 ¾	603
	Overall height	5 ¾	136

Model	Frame	List (\$)	Other options (\$)
CU2B1M	E8 Std	350	SDW 85
	E9 N/C		

CU2B2M

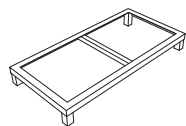

Description	Dimensions	(in)	(mm)
Double-section metal base Hardware included	Overall width	48 ¼	1226
	Overall depth	23 ¾	603
	Overall height	5 ¾	136

Model	Frame	List (\$)
CU2B2M	E8 Std	500
	E9 N/C	

CU2B3M

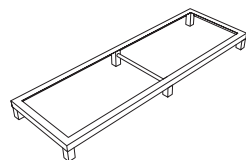

Description	Dimensions	(in)	(mm)
Triple-section metal base Hardware included	Overall width	72 ¾	1848
	Overall depth	23 ¾	603
	Overall height	5 ¾	136

Model	Frame	List (\$)
CU2B3M	E8 Std	600
	E9 N/C	

CU2-T2424

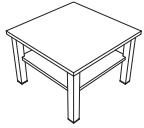

Description
Square table

Dimensions	(in)	(mm)
Overall width	24 ½	622
Overall depth	24 ½	622
Overall height	17 ¼	438

Model	Frame	List (\$)	Laminate finis
CU2-T2424	E8 Std	657	Specify code
	E9 N/C		

CU2-T2448

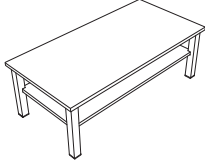

Description
Rectangular table

Dimensions	(in)	(mm)
Overall width	49	1245
Overall depth	24 ½	622
Overall height	17 ¼	438

Model	Frame	List (\$)	Laminate finis
CU2-T2448	E8 Std	826	Specify code
	E9 N/C		

CUBE 200 – SOLUTIONS

CUBE 200 – S1

\$1,764



- 1 CU205-A-TAR
- 1 CU2B1M

CUBE 200 – S3

\$5,946

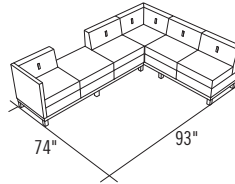

- 1 CU201
- 3 CU202
- 1 CU204
- 1 CU206
- 2 CU2B3M

CUBE 200 – S2

\$2,877

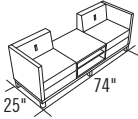

- 1 CU203
- 1 CU204
- 1 CU2-TS
- 1 CU2B3M

MODULAR, LOUNGE, AND PUBLIC AREAS

SPECIFICATIONS

- Storage units and tables ship assembled. Minimum assembly is required to mount units to the base.
- Fabric/fabric, fabric/vinyl and vinyl/vinyl dual upholstery is available. The first upholstery code is the backrest and a seat cushion, the second upholstery code is for the arms and structure. As for the ottoman, the first upholstery code is seat cushion, the second upholstery code is for the under structure.
- If dual upholstery combination is from two different grades, list price is the highest grade of the two.
- Tablet arm cannot be retrofitted on existing model.
- If optional electrical module is selected, the module will be located in left side of the front structure.
- 16-gauge steel base and belt.
- 3" soft dual wheel casters are available on the armchair only.
- Levelers allow up to 1 ½" height adjustment.
- Please refer to your Lacasse Sampler for laminate choices.
- Please refer to accessories on page 53 for ganging brackets and floor anchors.
- C.O.M./C.O.V.: please refer to page 54.
- Units from this series were tested and successfully met ANSI/BIFMA X5.4-2012 standards.

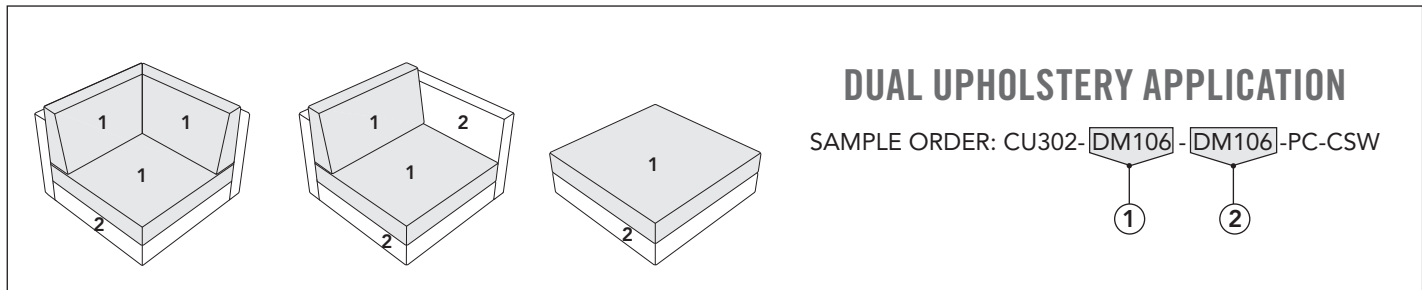

SAMPLE ORDER: CU302-DM106-DM106-PC-CSW

CU301

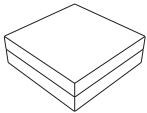

Description	Dimensions	(in)	(mm)	Dimensions	(in)	(mm)
Ottoman	Seat width	30 ½	781	Overall width	30 ½	775
	Seat depth	30 ½	781	Overall depth	30 ½	775
	Seat height	18	457	Overall height	18	457

Model	Upholstery / List (\$)	Other options (\$)
CU301	Grade 1	588
	Grade 2	599
	Grade 3	613
	Grade 4	626
	Grade 5	640
	Grade 6	654
	Grade 7	1,137
	Grade 8	681
	PC (1x)	600
	CSB	50
	CSW	50

CU302

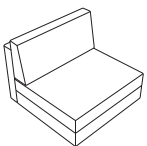

Description	Dimensions	(in)	(mm)	Dimensions	(in)	(mm)
Armless chair	Seat width	30	762	Overall width	30 ½	775
	Seat depth	19 ¾	502	Overall depth	30 ½	775
	Seat height	18	457	Overall height	32 ¾	832
	Back height	14 ¾	375			

Model	Upholstery / List (\$)	Other options (\$)
CU302	Grade 1	938
	Grade 2	960
	Grade 3	988
	Grade 4	1,015
	Grade 5	1,043
	Grade 6	1,070
	Grade 7	1,761
	Grade 8	1,125
	PC (1x)	600
	CSB	50
	CSW	50

CU303

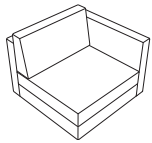

Description	Dimensions (in)	(mm)	Dimensions (in)	(mm)
Left-side armchair	Seat width	27	686	Overall width
	Seat depth	19 ¾	502	Overall depth
	Seat height	18	457	Overall height
	Back height	14 ¾	375	

Model	Upholstery / List (\$)	Tablet arm (\$)	Tablet finis	Other options (\$)
CU303	Grade 1	1,101	NA Std	NA Std
	Grade 2	1,126	TAL 407	Specify laminate code
	Grade 3	1,157		PC (1x) 600
	Grade 4	1,188		CSB 50
	Grade 5	1,220		CSW 50
	Grade 6	1,251		
	Grade 7	2,089		
	Grade 8	1,313		

CU304

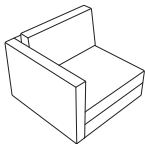

Description	Dimensions (in)	(mm)	Dimensions (in)	(mm)
Right-side armchair	Seat width	27	686	Overall width
	Seat depth	19 ¾	502	Overall depth
	Seat height	18	457	Overall height
	Back height	14 ¾	375	

Model	Upholstery / List (\$)	Tablet arm (\$)	Tablet finis	Other options (\$)
CU304	Grade 1	1,101	NA Std	NA Std
	Grade 2	1,126	TAL 407	Specify laminate code
	Grade 3	1,157		PC (1x) 600
	Grade 4	1,188		CSB 50
	Grade 5	1,220		CSW 50
	Grade 6	1,251		
	Grade 7	2,089		
	Grade 8	1,313		

CU305

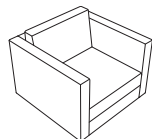

Description	Dimensions (in)	(mm)	Dimensions (in)	(mm)
Armchair	Seat width	24	610	Overall width
	Seat depth	19 ¾	502	Overall depth
	Seat height	18	457	Overall height
	Back height	14 ¾	375	

Model	Upholstery / List (\$)	Tablet arm (\$)	Tablet finis	Other options (\$)
CU305	Grade 1	1,238	NA Std	NA Std
	Grade 2	1,266	TAL 407	Specify laminate code
	Grade 3	1,300	TAR 407	PC (1x) 600
	Grade 4	1,335		CSB 50
	Grade 5	1,369		CSW 50
	Grade 6	1,403		
	Grade 7	2,501		
	Grade 8	1,472		

CU306

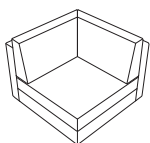

Description	Dimensions (in)	(mm)	Dimensions (in)	(mm)
Corner armchair	Seat width	19 ¾	502	Overall width
	Seat depth	19 ¾	502	Overall depth
	Seat height	18	457	Overall height
	Back height	14 ¾	375	

Model	Upholstery / List (\$)	Other options (\$)
CU306	Grade 1	1,345
	Grade 2	1,372
	Grade 3	1,407
	Grade 4	1,441
	Grade 5	1,475
	Grade 6	1,510
	Grade 7	2,607
	Grade 8	1,579

CU3-TS

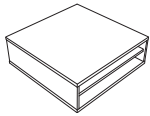

Description	Dimensions	(in)	(mm)
Single access storage unit Metal base not included	Overall width	30 ½	775
	Overall depth	30 ½	775
	Overall height	18	457

Model	List (\$)	Laminate finis	
CU3-TS	600	Specify code	

CU3-TD

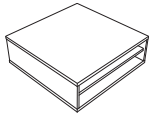

Description	Dimensions	(in)	(mm)
Double access storage unit Metal base not included	Overall width	30 ½	775
	Overall depth	30 ½	775
	Overall height	18	457

Model	List (\$)	Laminate finis	
CU3-TD	657	Specify code	

CU3-TF

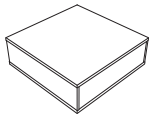

Description	Dimensions	(in)	(mm)
Closed unit Metal base not included	Overall width	30 ½	775
	Overall depth	30 ½	775
	Overall height	18	457

Model	List (\$)	Laminate finis	
CU3-TF	613	Specify code	

CU3B1M

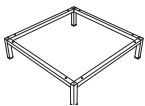

Description	Dimensions	(in)	(mm)
Single-section metal base Hardware included	Overall width	29 ¾	756
	Overall depth	29 ¾	756
	Overall height	7 ¾	197

Model	Frame	List (\$)	Other options (\$)
CU3B1M	E8 Std	438	SDW 85
	E9 N/C		

CU3B2M

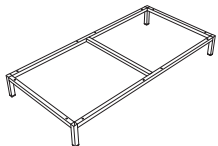

Description	Dimensions	(in)	(mm)
Double-section metal base Hardware included	Overall width	60 ¾	1530
	Overall depth	29 ¾	756
	Overall height	7 ¾	197

Model	Frame	List (\$)	
CU3B2M	E8 Std	532	
	E9 N/C		

CU3B3M

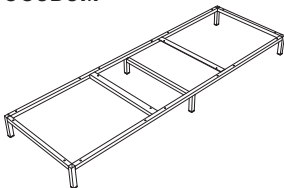

Description	Dimensions	(in)	(mm)
Triple-section metal base Hardware included	Overall width	90 ¾	2306
	Overall depth	29 ¾	756
	Overall height	7 ¾	197

Model	Frame	List (\$)	
CU3B3M	E8 Std	863	
	E9 N/C		

CU3-T2424

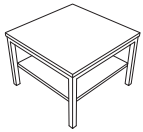

Description

Square table
Metal frame

Dimensions	(in)	(mm)
Overall width	24 ½	622
Overall depth	24 ½	622
Overall height	18	457

Model	Frame	List (\$)	Laminate finis
CU3-T2424	E8 Std E9 N/C	813	Specify code

CU3-T3030

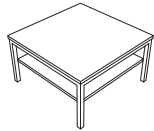

Description

Square table

Dimensions	(in)	(mm)
Overall width	30 ½	775
Overall depth	30 ½	775
Overall height	18	457

Model	Frame	List (\$)	Laminate finis
CU3-T3030	E8 Std E9 N/C	988	Specify code

CU3-T2448

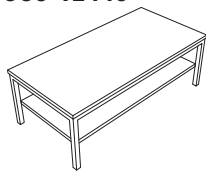

Description

Rectangular table
Metal frame

Dimensions	(in)	(mm)
Overall width	49	1245
Overall depth	24 ½	622
Overall height	18	457

Model	Frame	List (\$)	Laminate finis
CU3-T2448	E8 Std E9 N/C	1,051	Specify code

CU3-T3030L

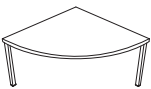

Description

Luna table
Metal frame

Dimensions	(in)	(mm)
Overall width	30 ½	775
Overall depth	30 ½	775
Overall height	18	457

Model	Frame	List (\$)	Laminate finis
CU3-T3030L	E8 Std E9 N/C	782	Specify code

CUBE 300 – SOLUTIONS

CUBE 300 – S1

\$6,598

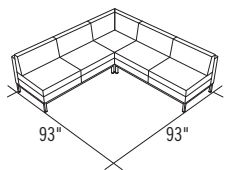

- 4 CU302
- 1 CU306
- 1 CU3B1M
- 2 CU3B2M

CUBE 300 – S4

\$9,431

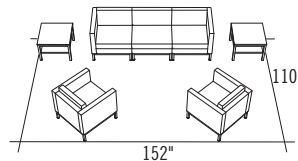

- 1 CU302
- 1 CU303
- 1 CU304
- 2 CU305
- 5 CU3B1M
- 2 CU3-T2424

CUBE 300 – S2

\$7,905

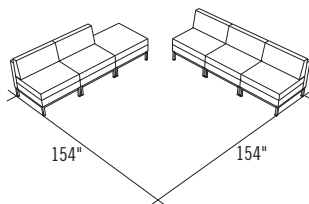

- 1 CU301
- 5 CU302
- 6 CU3B1M

CUBE 300 – S5

\$10,282

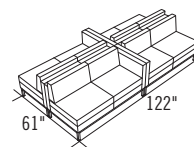

- 4 CU302
- 2 CU303
- 2 CU304
- 4 CU3B2M

CUBE 300 – S3

\$6,848

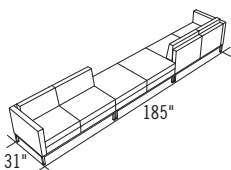

- 2 CU301
- 2 CU302
- 2 CU304
- 3 CU3B2M

CUBE 300 – S6

\$4,215

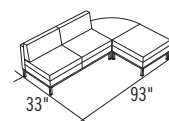

- 1 CU301
- 2 CU302
- 1 CU3-T3030L
- 1 CU3B1M
- 1 CU3B2M

LOUNGE

SPECIFICATIONS

- All models ship assembled.
- Fabric/fabric, fabric/vinyl and vinyl/vinyl dual upholstery is available. The first upholstery code is the backrest and seat shell, the second upholstery code is for the arms.
- If dual upholstery combination is from two different grades, list price is the highest grade of the two.
- Laminate tray to match legs and armrests wood finish.
- Refer to page 59 for the 4 wood finishes available.
- 2" hard dual wheel casters are available.
- C.O.M./C.O.V.: please refer to page 54.

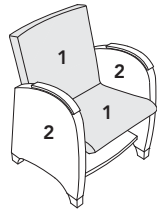

DUAL UPHOLSTERY APPLICATION

SAMPLE ORDER: FL1-W3-MG054-MG054-DCH

1

2

SAMPLE ORDER: FL1-W3-MG054-MG054-DCH

FL1



Description	Dimensions	(in)	(mm)	Dimensions	(in)	(mm)
Armchair	Seat width	21 ½	546	Overall width	27 ½	699
Monocoque shell	Seat depth	19	483	Overall depth	26 ½	673
Wood armrests and legs	Seat height	18 ½	470	Overall height	33	838
Thermofused laminate tray	Back height	18	457			

Model	Frame	Upholstery / List (\$)	Laminate match	Other options (\$)
FL1	W1 Std	Grade 1 1,232	NTL (W1)	HDW 85
	W2 N/C	Grade 2 1,250	CER (W2)	
	W3 N/C	Grade 3 1,271	DCH (W3)	
	W4 N/C	Grade 4 1,293	TWT (W4)	
		Grade 5 1,315		
		Grade 6 1,337		
		Grade 7 1,880		
		Grade 8 1,381		

HIP HOP AND HIP HOP JUNIOR

MODULAR, LOUNGE AND PUBLIC AREAS

SPECIFICATIONS

- All models ship assembled.
- Fabric/fabric, fabric/vinyl and vinyl/vinyl dual upholstery is available for the double ogive and chairs only. The first upholstery code is the backrest, the second upholstery code is for the seat.
- If dual upholstery combination is from two different grades, list price is the highest grade of the two.
- Leather is not available for these series.
- ¼" thick bended steel legs, 9 ½"H for Hip Hop and 6"H for Hip Hop Junior.
- Please refer to your Lacasse Sampler for laminate choices.
- Please refer to accessories on page 53 for ganging brackets.
- C.O.M./C.O.V.: please refer to page 54.

CALCULATING RADIUS:

The radius is the linear distance calculated from the center of the circle (point 0) to the inner circumference of the module.

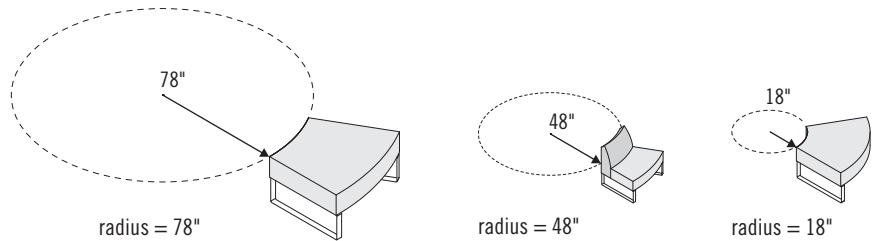

CALCULATING DEGREES:

The degree of the angle is calculated by dividing the entire circumference (360°) by the number of modules. E.g.: 360 divided by 6 modular units provides an angle of 60°. Thus, 12 modules of 30° form a circle (360°).

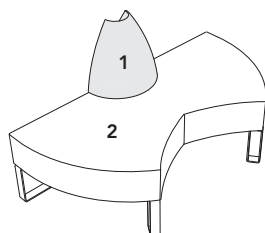
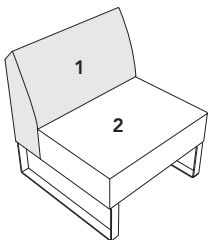
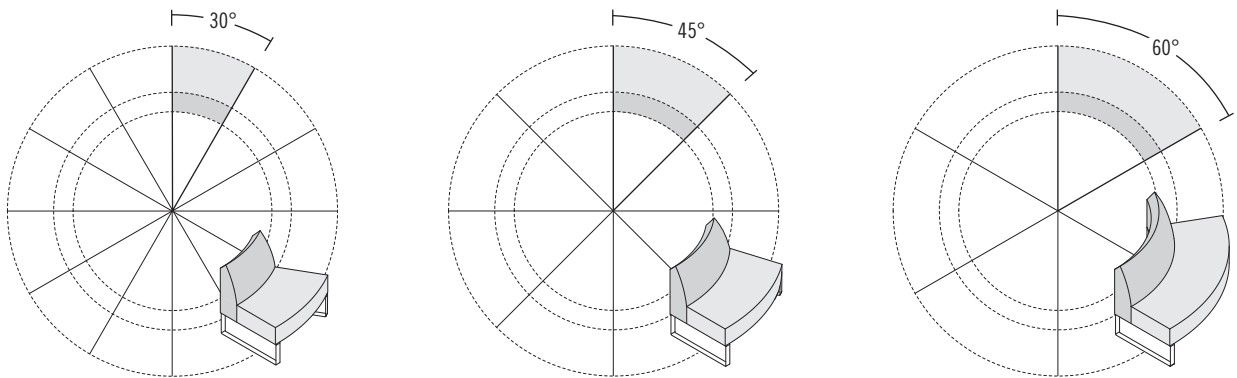

DUAL UPHOLSTERY APPLICATION

SAMPLE ORDER: HV-E9-CY32-HU10

1

2

HV

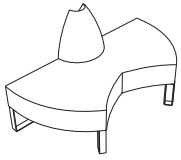

Description	Dimensions	(in)	(mm)	Dimensions	(in)	(mm)
Double ogive seat	Seat width	60	1524	Overall width	60	1524
	Seat depth	21	533	Overall depth	30	762
	Seat height	18	457	Overall height	34	864
	Back height	16	406			

Model	Frame	Upholstery / List (\$)
HV	E8 Std	Grade 1 2,577
	E9 N/C	Grade 2 2,592
		Grade 3 2,610
		Grade 4 2,629
		Grade 5 2,648
		Grade 6 2,667
		Grade 8 2,704

HO

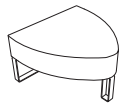

Description	Dimensions	(in)	(mm)	Dimensions	(in)	(mm)
Ogive	Seat width	30	762	Overall width	30	762
	Seat depth	30	762	Overall depth	30	762
	Seat height	18	457	Overall height	18	457

Model	Frame	Upholstery / List (\$)
HO	E8 Std	Grade 1 1,226
	E9 N/C	Grade 2 1,237
		Grade 3 1,251
		Grade 4 1,265
		Grade 5 1,279
		Grade 6 1,293
		Grade 8 1,321

H30

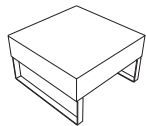

Description	Dimensions	(in)	(mm)	Dimensions	(in)	(mm)
Square bench	Seat width	30	762	Overall width	30	762
	Seat depth	30	762	Overall depth	30	762
	Seat height	18	457	Overall height	18	457

Model	Frame	Upholstery / List (\$)
H30	E8 Std	Grade 1 969
	E9 N/C	Grade 2 979
		Grade 3 992
		Grade 4 1,004
		Grade 5 1,017
		Grade 6 1,029
		Grade 8 1,054

H30X

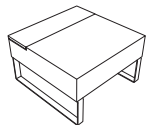

Description	Dimensions	(in)	(mm)	Dimensions	(in)	(mm)
Mixed square bench	Seat width	30	762	Overall width	30	762
	Seat depth	21	533	Overall depth	30	762
	Seat height	18	457	Overall height	18	457

Model	Frame	Upholstery / List (\$)	Tablet finis
H30X	E8 Std	Grade 1 1,144	Specify laminate code
	E9 N/C	Grade 2 1,154	
		Grade 3 1,167	
		Grade 4 1,180	
		Grade 5 1,192	
		Grade 6 1,205	
		Grade 8 1,230	

HC30

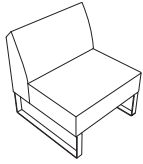

Description	Dimensions (in)	(mm)	Dimensions (in)	(mm)		
Straight chair	Seat width	30	762	Overall width	30	762
	Seat depth	21	533	Overall depth	30	762
	Seat height	18	457	Overall height	34	864
	Back height	16	406			
	Back width	30	762			

Model	Frame	Upholstery / List (\$)	
HC30	E8 Std	Grade 1	1,370
		Grade 2	1,384
	E9 N/C	Grade 3	1,402
		Grade 4	1,420
		Grade 5	1,439
		Grade 6	1,457
		Grade 7	1,475
		Grade 8	1,493

H60

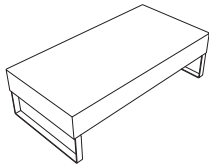

Description	Dimensions (in)	(mm)	Dimensions (in)	(mm)		
Rectangular bench	Seat width	60	1524	Overall width	60	1524
	Seat depth	30	762	Overall depth	30	762
	Seat height	18	457	Overall height	34	864
	Back height	16	406			

Model	Frame	Upholstery / List (\$)	
H60	E8 Std	Grade 1	1,582
		Grade 2	1,596
	E9 N/C	Grade 3	1,613
		Grade 4	1,630
		Grade 5	1,646
		Grade 6	1,663
		Grade 7	1,680
		Grade 8	1,697

H60X

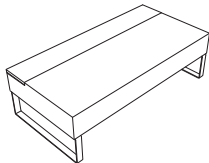

Description	Dimensions (in)	(mm)	Dimensions (in)	(mm)		
Mixed rectangular bench	Seat width	60	1524	Overall width	60	1524
	Seat depth	30	762	Overall depth	30	762
	Seat height	18	457	Overall height	18	457

Model	Frame	Upholstery / List (\$)	Tablet finis	
H60X	E8 Std	Grade 1	1,839	Specify laminate code
		Grade 2	1,853	
	E9 N/C	Grade 3	1,870	
		Grade 4	1,888	
		Grade 5	1,905	
		Grade 6	1,923	
		Grade 7	1,940	
		Grade 8	1,958	

HC60

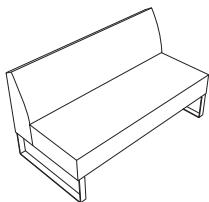

Description	Dimensions (in)	(mm)	Dimensions (in)	(mm)		
Straight chair	Seat width	60	1524	Overall width	60	1524
	Seat depth	21	533	Overall depth	30	762
	Seat height	18	457	Overall height	34	864
	Back height	16	406			
	Back width	60	1524			

Model	Frame	Upholstery / List (\$)	
HC60	E8 Std	Grade 1	2,201
		Grade 2	2,230
	E9 N/C	Grade 3	2,266
		Grade 4	2,301
		Grade 5	2,337
		Grade 6	2,373
		Grade 7	2,409
		Grade 8	2,444

H1860

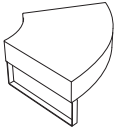

Description	Dimensions	(in)	(mm)	Dimensions	(in)	(mm)
Wedge bench	Seat width	48	1219	Overall width	48	1219
Radius = 18"	Seat depth	30	762	Overall depth	32 ½	826
Degree = 60°	Seat height	18	457	Overall height	18	457

Model	Frame	Upholstery / List (\$)
H1860	E8 Std	Grade 1 1,532
		Grade 2 1,545
	E9 N/C	Grade 3 1,560
		Grade 4 1,576
		Grade 5 1,592
		Grade 6 1,607
		Grade 7 1,623
		Grade 8 1,639

HX1860

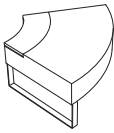

Description	Dimensions	(in)	(mm)	Dimensions	(in)	(mm)
Mixed wedge bench	Seat width	48	1219	Overall width	48	1219
Radius = 18"	Seat depth	21	533	Overall depth	32 ½	826
Degree = 60°	Seat height	18	457	Overall height	18	457

Model	Frame	Upholstery / List (\$)	Tablet finis
HX1860	E8 Std	Grade 1 1,745	Specify laminate code
		Grade 2 1,757	
	E9 N/C	Grade 3 1,773	
		Grade 4 1,789	
		Grade 5 1,804	
		Grade 6 1,820	
		Grade 7 1,836	
		Grade 8 1,851	

H1860X

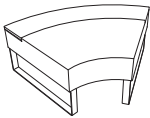

Description	Dimensions	(in)	(mm)	Dimensions	(in)	(mm)
Mixed wedge bench	Seat width	39	991	Overall width	48	1219
Radius = 18"	Seat depth	21	533	Overall depth	32 ½	826
Degree = 60°	Seat height	18	457	Overall height	18	457

Model	Frame	Upholstery / List (\$)	Tablet finis
H1860X	E8 Std	Grade 1 1,745	Specify laminate code
		Grade 2 1,757	
	E9 N/C	Grade 3 1,773	
		Grade 4 1,789	
		Grade 5 1,804	
		Grade 6 1,820	
		Grade 7 1,836	
		Grade 8 1,851	

HC1860

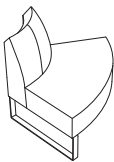

Description	Dimensions	(in)	(mm)	Dimensions	(in)	(mm)
Wedge chair	Seat width	48	1219	Overall width	48	1219
Radius = 18"	Seat depth	21	533	Overall depth	32 ½	826
Degree = 60°	Seat height	18	457	Overall height	34	864
	Back height	16	406			
	Back width	27	686			

Model	Frame	Upholstery / List (\$)
HC1860	E8 Std	Grade 1 1,895
		Grade 2 1,915
	E9 N/C	Grade 3 1,940
		Grade 4 1,965
		Grade 5 1,990
		Grade 6 2,015
		Grade 7 2,040
		Grade 8 2,065

H1860C

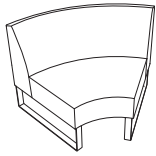

Description	Dimensions (in)	(mm)	Dimensions (in)	(mm)		
Wedge chair	Seat width	39	991	Overall width	48	1219
Radius = 18"	Seat depth	21	533	Overall depth	32 1/2	826
Degree = 60°	Seat height	18	457	Overall height	34	864
	Back height	16	406			
	Back width	39	991			

Model	Frame	Upholstery / List (\$)	
H1860C	E8 Std	Grade 1	1,895
		Grade 2	1,916
	E9 N/C	Grade 3	1,943
		Grade 4	1,969
		Grade 5	1,996
		Grade 6	2,023
		Grade 7	
		Grade 8	2,076

H4830

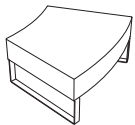

Description	Dimensions (in)	(mm)	Dimensions (in)	(mm)		
Wedge bench	Seat width	40 1/4	1022	Overall width	40 1/4	1022
Radius = 48"	Seat depth	30	762	Overall depth	31 3/4	806
Degree = 30°	Seat height	18	457	Overall height	18	457

Model	Frame	Upholstery / List (\$)	
H4830	E8 Std	Grade 1	1,420
		Grade 2	1,431
	E9 N/C	Grade 3	1,444
		Grade 4	1,458
		Grade 5	1,472
		Grade 6	1,486
		Grade 7	
		Grade 8	1,513

HX4830

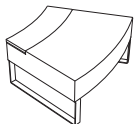

Description	Dimensions (in)	(mm)	Dimensions (in)	(mm)		
Mixed wedge bench	Seat width	40 1/4	1022	Overall width	40 1/4	1022
Radius = 48"	Seat depth	21	533	Overall depth	31 3/4	806
Degree = 30°	Seat height	18	457	Overall height	18	457

Model	Frame	Upholstery / List (\$)	Tablet finis	
HX4830	E8 Std	Grade 1	1,632	Specify laminate code
		Grade 2	1,642	
	E9 N/C	Grade 3	1,655	
		Grade 4	1,667	
		Grade 5	1,680	
		Grade 6	1,692	
		Grade 7		
		Grade 8	1,717	

H4830X

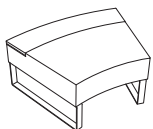

Description	Dimensions (in)	(mm)	Dimensions (in)	(mm)		
Mixed wedge bench	Seat width	35 3/4	909	Overall width	40 1/4	1022
Radius = 48"	Seat depth	21	533	Overall depth	31 3/4	806
Degree = 30°	Seat height	18	457	Overall height	18	457

Model	Frame	Upholstery / List (\$)	Tablet finis	
H4830X	E8 Std	Grade 1	1,632	Specify laminate code
		Grade 2	1,642	
	E9 N/C	Grade 3	1,655	
		Grade 4	1,667	
		Grade 5	1,680	
		Grade 6	1,692	
		Grade 7		
		Grade 8	1,717	

HC4830

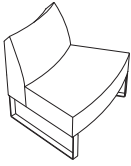

Description	Dimensions	(in)	(mm)	Dimensions	(in)	(mm)
Wedge chair	Seat width	40 ¼	1022	Overall width	40 ¼	1022
Radius = 48"	Seat depth	21	533	Overall depth	31 ¾	806
Degree = 30°	Seat height	18	457	Overall height	34	864
	Back height	16	406			
	Back width	29 ½	749			

Model	Frame	Upholstery / List (\$)	
HC4830	E8 Std	Grade 1	1,789
		Grade 2	1,809
	E9 N/C	Grade 3	1,834
		Grade 4	1,859
		Grade 5	1,884
		Grade 6	1,909
		Grade 7	
		Grade 8	1,959

H4830C

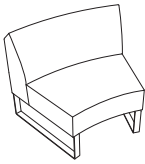

Description	Dimensions	(in)	(mm)	Dimensions	(in)	(mm)
Wedge chair	Seat width	35 ¾	909	Overall width	40 ¼	1022
Radius = 48"	Seat depth	21	533	Overall depth	31 ¾	806
Degree = 30°	Seat height	18	457	Overall height	34	864
	Back height	16	406			
	Back width	35 ¾	909			

Model	Frame	Upholstery / List (\$)	
H4830C	E8 Std	Grade 1	1,789
		Grade 2	1,809
	E9 N/C	Grade 3	1,834
		Grade 4	1,859
		Grade 5	1,884
		Grade 6	1,909
		Grade 7	
		Grade 8	1,959

H4845

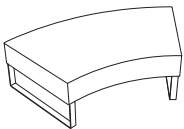

Description	Dimensions	(in)	(mm)	Dimensions	(in)	(mm)
Wedge bench	Seat width	60	1524	Overall width	60	1524
Radius = 48"	Seat depth	30	762	Overall depth	34	864
Degree = 45°	Seat height	18	457	Overall height	18	457

Model	Frame	Upholstery / List (\$)	
H4845	E8 Std	Grade 1	1,870
		Grade 2	1,882
	E9 N/C	Grade 3	1,898
		Grade 4	1,914
		Grade 5	1,929
		Grade 6	1,945
		Grade 7	
		Grade 8	1,976

HX4845

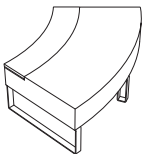

Description	Dimensions	(in)	(mm)	Dimensions	(in)	(mm)
Mixed wedge bench	Seat width	60	1524	Overall width	60	1524
Radius = 48"	Seat depth	21	533	Overall depth	34	864
Degree = 45°	Seat height	18	457	Overall height	18	457

Model	Frame	Upholstery / List (\$)		Tablet finis
HX4845	E8 Std	Grade 1	2,158	Specify laminate code
		Grade 2	2,170	
	E9 N/C	Grade 3	2,186	
		Grade 4	2,201	
		Grade 5	2,217	
		Grade 6	2,233	
		Grade 7		
		Grade 8	2,264	

H4845X

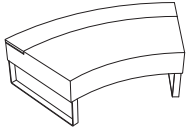

Description	Dimensions (in)	(mm)	Dimensions (in)	(mm)		
Mixed wedge bench	Seat width	53	1346	Overall width	60	1524
Radius = 48"	Seat depth	21	533	Overall depth	34	864
Degree = 45°	Seat height	18	457	Overall height	18	457

Model	Frame	Upholstery / List (\$)	Tablet finis
H4845X	E8 Std	Grade 1	2,158
		Grade 2	2,170
	E9 N/C	Grade 3	2,186
		Grade 4	2,201
	Grade 5	2,217	
	Grade 6	2,233	
	Grade 7	2,249	
	Grade 8	2,264	

HC4845

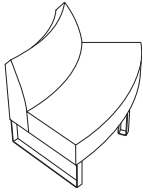

Description	Dimensions (in)	(mm)	Dimensions (in)	(mm)		
Wedge chair	Seat width	44	1118	Overall width	60	1524
Radius = 48"	Seat depth	21	533	Overall depth	34	864
Degree = 45°	Seat height	18	457	Overall height	34	864
	Back height	16	406			
	Back width	43 3/8	1108			

Model	Frame	Upholstery / List (\$)	
HC4845	E8 Std	Grade 1	2,364
		Grade 2	2,389
	E9 N/C	Grade 3	2,420
		Grade 4	2,452
	Grade 5	2,483	
	Grade 6	2,514	
	Grade 7	2,545	
	Grade 8	2,577	

H4845C

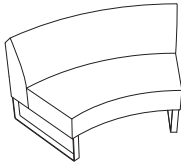

Description	Dimensions (in)	(mm)	Dimensions (in)	(mm)		
Wedge chair	Seat width	53	1346	Overall width	60	1524
Radius = 48"	Seat depth	21	533	Overall depth	34	864
Degree = 45°	Seat height	18	457	Overall height	34	864
	Back height	16	406			
	Back width	53	1346			

Model	Frame	Upholstery / List (\$)	
H4845C	E8 Std	Grade 1	2,364
		Grade 2	2,389
	E9 N/C	Grade 3	2,420
		Grade 4	2,452
	Grade 5	2,483	
	Grade 6	2,514	
	Grade 7	2,545	
	Grade 8	2,577	

H4860

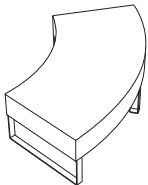

Description	Dimensions (in)	(mm)	Dimensions (in)	(mm)		
Wedge bench	Seat width	78	1981	Overall width	78	1981
Radius = 48"	Seat depth	30	762	Overall depth	37	940
Degree = 60°	Seat height	18	457	Overall height	18	457

Model	Frame	Upholstery / List (\$)	
H4860	E8 Std	Grade 1	2,258
		Grade 2	2,273
	E9 N/C	Grade 3	2,291
		Grade 4	2,310
	Grade 5	2,329	
	Grade 6	2,348	
	Grade 7	2,367	
	Grade 8	2,385	

HX4860

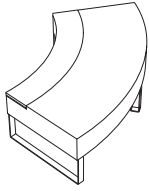

Description		Dimensions (in)		Dimensions (mm)		Dimensions (in)		Dimensions (mm)	
Mixed wedge bench		Seat width	78	1981	Overall width	78	1981		
Radius = 48"		Seat depth	21	533	Overall depth	37	940		
Degree = 60°		Seat height	18	457	Overall height	18	457		

Model	Frame	Upholstery / List (\$)		Tablet finis
HX4860	E8 Std	Grade 1	2,564	Specify laminate code
	E9 N/C	Grade 2	2,579	
Grade 3		2,598		
Grade 4		2,617		
Grade 5		2,635		
Grade 6		2,654		
Grade 8		2,692		

H4860X

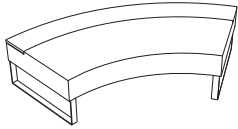

Description		Dimensions (in)		Dimensions (mm)		Dimensions (in)		Dimensions (mm)	
Mixed wedge bench		Seat width	57	1448	Overall width	78	1981		
Radius = 48"		Seat depth	21	533	Overall depth	37	940		
Degree = 60°		Seat height	18	457	Overall height	18	457		

Model	Frame	Upholstery / List (\$)		Tablet finis
H4860X	E8 Std	Grade 1	2,564	Specify laminate code
	E9 N/C	Grade 2	2,579	
Grade 3		2,598		
Grade 4		2,617		
Grade 5		2,635		
Grade 6		2,654		
Grade 8		2,692		

HC4860

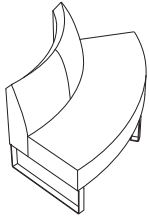

Description		Dimensions (in)		Dimensions (mm)		Dimensions (in)		Dimensions (mm)	
Wedge chair		Seat width	78	1981	Overall width	78	1981		
Radius = 48"		Seat depth	21	533	Overall depth	37	940		
Degree = 60°		Seat height	18	457	Overall height	34	864		
		Back height	16	406					
		Back width	57	1448					

Model	Frame	Upholstery / List (\$)		Tablet finis
HC4860	E8 Std	Grade 1	2,977	
	E9 N/C	Grade 2	3,005	
Grade 3		3,041		
Grade 4		3,077		
Grade 5		3,112		
Grade 6		3,148		
Grade 8		3,219		

H4860C

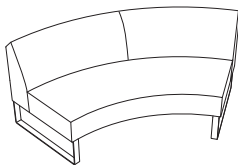

Description		Dimensions (in)		Dimensions (mm)		Dimensions (in)		Dimensions (mm)	
Wedge chair		Seat width	69 1/4	1759	Overall width	78	1981		
Radius = 48"		Seat depth	21	533	Overall depth	37	940		
Degree = 60°		Seat height	18	457	Overall height	34	864		
		Back height	16	406					
		Back width	69 1/4	1759					

Model	Frame	Upholstery / List (\$)		Tablet finis
H4860C	E8 Std	Grade 1	2,977	
	E9 N/C	Grade 2	3,007	
Grade 3		3,044		
Grade 4		3,082		
Grade 5		3,119		
Grade 6		3,157		
Grade 8		3,232		

H7830

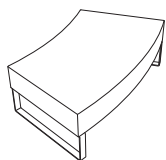

Description	Dimensions (in)	(mm)	Dimensions (in)	(mm)		
Wedge bench	Seat width	56	1422	Overall width	56	1422
Radius = 78"	Seat depth	30	762	Overall depth	32 3/4	832
Degree = 30°	Seat height	18	457	Overall height	18	457

Model	Frame	Upholstery / List (\$)
H7830	E8 Std	Grade 1 1,745
	E9 N/C	Grade 2 1,760
		Grade 3 1,779
		Grade 4 1,797
		Grade 5 1,816
		Grade 6 1,835
		Grade 8 1,872

HX7830

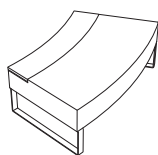

Description	Dimensions (in)	(mm)	Dimensions (in)	(mm)		
Mixed wedge bench	Seat width	56	1422	Overall width	56	1422
Radius = 78"	Seat depth	21	533	Overall depth	32 3/4	832
Degree = 30°	Seat height	18	457	Overall height	18	457

Model	Frame	Upholstery / List (\$)	Tablet finis
HX7830	E8 Std	Grade 1 1,989	Specify laminate code
	E9 N/C	Grade 2 2,004	
		Grade 3 2,023	
		Grade 4 2,041	
		Grade 5 2,060	
		Grade 6 2,079	
		Grade 8 2,116	

H7830X

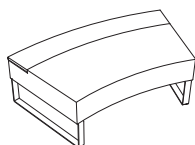

Description	Dimensions (in)	(mm)	Dimensions (in)	(mm)		
Mixed wedge bench	Seat width	51	1295	Overall width	56	1422
Radius = 78"	Seat depth	21	533	Overall depth	32 3/4	832
Degree = 30°	Seat height	18	457	Overall height	18	457

Model	Frame	Upholstery / List (\$)	Tablet finis
H7830X	E8 Std	Grade 1 1,989	Specify laminate code
	E9 N/C	Grade 2 2,004	
		Grade 3 2,023	
		Grade 4 2,041	
		Grade 5 2,060	
		Grade 6 2,079	
		Grade 8 2,116	

HC7830

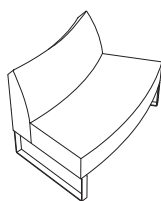

Description	Dimensions (in)	(mm)	Dimensions (in)	(mm)		
Wedge chair	Seat width	56	1422	Overall width	56	1422
Radius = 78"	Seat depth	21	533	Overall depth	32 3/4	832
Degree = 30°	Seat height	18	457	Overall height	34	864
	Back height	16	406			
	Back width	45	1143			

Model	Frame	Upholstery / List (\$)
HC7830	E8 Std	Grade 1 2,427
	E9 N/C	Grade 2 2,449
		Grade 3 2,477
		Grade 4 2,505
		Grade 5 2,533
		Grade 6 2,562
		Grade 8 2,618

H7830C

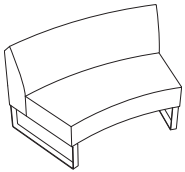

Description	Dimensions	(in)	(mm)	Dimensions	(in)	(mm)
Wedge chair	Seat width	51 ½	1308	Overall width	56	1422
Radius = 78"	Seat depth	21	533	Overall depth	32 ¾	832
Degree = 30°	Seat height	18	457	Overall height	34	864
	Back height	16	406			
	Back width	51 ½	1308			

Model	Frame	Upholstery / List (\$)
H7830C	E8 Std	Grade 1 2,427
		Grade 2 2,452
	E9 N/C	Grade 3 2,483
		Grade 4 2,514
		Grade 5 2,545
		Grade 6 2,577
		Grade 7 2,608
		Grade 8 2,639

H7845

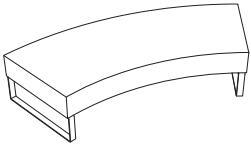

Description	Dimensions	(in)	(mm)	Dimensions	(in)	(mm)
Wedge bench	Seat width	83	2108	Overall width	83	2108
Radius = 78"	Seat depth	30	762	Overall depth	36	915
Degree = 45°	Seat height	18	457	Overall height	18	457

Model	Frame	Upholstery / List (\$)
H7845	E8 Std	Grade 1 2,258
		Grade 2 2,275
	E9 N/C	Grade 3 2,297
		Grade 4 2,319
		Grade 5 2,341
		Grade 6 2,363
		Grade 7 2,385
		Grade 8 2,407

HX7845

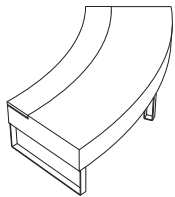

Description	Dimensions	(in)	(mm)	Dimensions	(in)	(mm)
Mixed wedge bench	Seat width	83	2108	Overall width	83	2108
Radius = 78"	Seat depth	21	533	Overall depth	36	915
Degree = 45°	Seat height	18	457	Overall height	18	457

Model	Frame	Upholstery / List (\$)	Tablet finis
HX7845	E8 Std	Grade 1 2,614	Specify laminate code
		Grade 2 2,632	
	E9 N/C	Grade 3 2,654	
		Grade 4 2,675	
		Grade 5 2,697	
		Grade 6 2,719	
		Grade 7 2,741	
		Grade 8 2,763	

H7845X

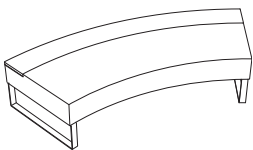

Description	Dimensions	(in)	(mm)	Dimensions	(in)	(mm)
Mixed wedge bench	Seat width	83	2108	Overall width	83	2108
Radius = 78"	Seat depth	21	533	Overall depth	36	915
Degree = 45°	Seat height	18	457	Overall height	18	457

Model	Frame	Upholstery / List (\$)	Tablet finis
H7845X	E8 Std	Grade 1 2,614	Specify laminate code
		Grade 2 2,632	
	E9 N/C	Grade 3 2,654	
		Grade 4 2,675	
		Grade 5 2,697	
		Grade 6 2,719	
		Grade 7 2,741	
		Grade 8 2,763	

HC7845

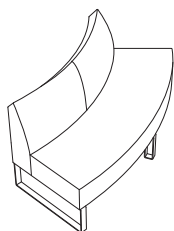

Description	Dimensions (in)	(mm)	Dimensions (in)	(mm)		
Wedge chair	Seat width	83	2108	Overall width	83	2108
Radius = 78"	Seat depth	21	533	Overall depth	36	915
Degree = 45°	Seat height	18	457	Overall height	34	864
	Back height	16	406			
	Back width	67	1702			

Model	Frame	Upholstery / List (\$)
HC7845	E8 Std	Grade 1 3,208
	E9 N/C	Grade 2 3,243
		Grade 3 3,287
		Grade 4 3,331
		Grade 5 3,375
		Grade 6 3,418
		Grade 8 3,506

H7845C

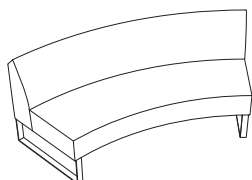

Description	Dimensions (in)	(mm)	Dimensions (in)	(mm)		
Wedge chair	Seat width	76	1930	Overall width	83	2108
Radius = 78"	Seat depth	21	533	Overall depth	36	915
Degree = 45°	Seat height	18	457	Overall height	34	864
	Back height	16	406			
	Back width	76	1930			

Model	Frame	Upholstery / List (\$)
H7845C	E8 Std	Grade 1 3,208
	E9 N/C	Grade 2 3,243
		Grade 3 3,287
		Grade 4 3,331
		Grade 5 3,375
		Grade 6 3,418
		Grade 8 3,506

HR24



Description	Dimensions (in)	(mm)
Round ottoman	Overall width	24 610
	Overall depth	24 610
	Overall height	18 457

Model	Frame	Upholstery / List (\$)
HR24	E8 Std	Grade 1 907
	E9 N/C	Grade 2 915
		Grade 3 925
		Grade 4 935
		Grade 5 945
		Grade 6 955
		Grade 8 975

HR36

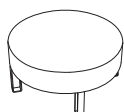

Description	Dimensions (in)	(mm)
Round ottoman	Overall width	36 914
	Overall depth	36 914
	Overall height	18 457

Model	Frame	Upholstery / List (\$)
HR36	E8 Std	Grade 1 1,163
	E9 N/C	Grade 2 1,176
		Grade 3 1,191
		Grade 4 1,207
		Grade 5 1,223
		Grade 6 1,238
		Grade 8 1,270

HR48

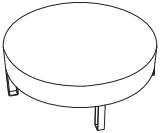

Description		Dimensions	(in)	(mm)
Round ottoman		Overall width	48	1219
		Overall depth	48	1219
		Overall height	18	457

Model	Frame	Upholstery / List (\$)	
HR48	E8 Std	Grade 1	1,614
		Grade 2	1,631
	E9 N/C	Grade 3	1,653
		Grade 4	1,675
		Grade 5	1,697
		Grade 6	1,719
		Grade 7	1,741
		Grade 8	1,762

HRT24



Description		Dimensions	(in)	(mm)
Round table		Seat width	24	610
		Seat depth	24	610
		Seat height	18	457

Model	Frame	Upholstery / List (\$)		Laminate finis
HRT24	E8 Std	Grade 1	1,063	Specify code
		Grade 2	1,069	
	E9 N/C	Grade 3	1,077	
		Grade 4	1,084	
		Grade 5	1,092	
		Grade 6	1,099	
		Grade 7	1,106	
		Grade 8	1,114	

HRT36

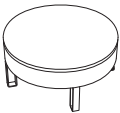

Description		Dimensions	(in)	(mm)
Round table		Seat width	36	915
		Seat depth	36	915
		Seat height	18	457

Model	Frame	Upholstery / List (\$)		Laminate finis
HRT36	E8 Std	Grade 1	1,463	Specify code
		Grade 2	1,471	
	E9 N/C	Grade 3	1,481	
		Grade 4	1,491	
		Grade 5	1,501	
		Grade 6	1,511	
		Grade 7	1,521	
		Grade 8	1,531	

HRT48

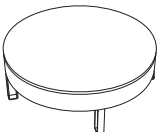

Description		Dimensions	(in)	(mm)
Round table		Overall width	48	1219
		Overall depth	48	1219
		Overall height	18	457

Model	Frame	Upholstery / List (\$)		Laminate finis
HRT48	E8 Std	Grade 1	2,033	Specify code
		Grade 2	2,040	
	E9 N/C	Grade 3	2,048	
		Grade 4	2,057	
		Grade 5	2,066	
		Grade 6	2,075	
		Grade 7	2,084	
		Grade 8	2,092	

HRTM36



Description	Dimensions	(in)	(mm)
Mixed table ottoman	Seat width	36	915
	Seat depth	36	915
	Seat height	18	457

Model	Frame	Upholstery / List (\$)	Laminate finis
HRTM36	E8 Std	Grade 1 1,420	Specify code
	E9 N/C	Grade 2 1,428	
		Grade 3 1,439	
		Grade 4 1,450	
		Grade 5 1,461	
		Grade 6 1,472	
		Grade 8 1,494	

H RTP48

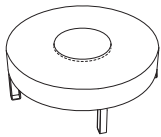

Description	Dimensions	(in)	(mm)
Mixed table ottoman	Overall width	48	1219
	Overall depth	48	1219
	Overall height	18	457

Model	Frame	Upholstery / List (\$)	Laminate finis
H RTP48	E8 Std	Grade 1 2,095	Specify code
	E9 N/C	Grade 2 2,113	
		Grade 3 2,134	
		Grade 4 2,156	
		Grade 5 2,178	
		Grade 6 2,200	
		Grade 8 2,244	

HOT

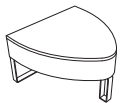

Description	Dimensions	(in)	(mm)
Ogive table	Seat width	30	762
	Seat depth	30	762
	Seat height	18	457

Model	Frame	Upholstery / List (\$)	Laminate finis
HOT	E8 Std	Grade 1 1,451	Specify code
	E9 N/C	Grade 2 1,455	
		Grade 3 1,461	
		Grade 4 1,467	
		Grade 5 1,472	
		Grade 6 1,478	
		Grade 8 1,489	

HT30

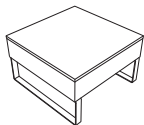

Description	Dimensions	(in)	(mm)
Square table	Seat width	30	762
	Seat depth	30	762
	Seat height	18	457

Model	Frame	Upholstery / List (\$)	Laminate finis
HT30	E8 Std	Grade 1 1,207	Specify code
	E9 N/C	Grade 2 1,212	
		Grade 3 1,217	
		Grade 4 1,223	
		Grade 5 1,228	
		Grade 6 1,234	
		Grade 8 1,245	

HT60

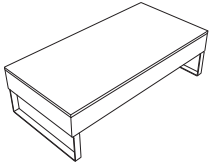

Description	Dimensions	(in)	(mm)
Rectangular table	Seat width	60	1524
	Seat depth	30	762
	Seat height	18	457

Model	Frame	Upholstery / List (\$)	Laminate finis
HT60	E8 Std	Grade 1	1,870
		Grade 2	1,881
	E9 N/C	Grade 3	1,895
		Grade 4	1,908
		Grade 5	1,922
		Grade 6	1,936
		Grade 7	1,950
		Grade 8	1,964

HA

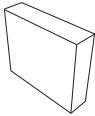

Description	Dimensions	(in)	(mm)
Upholstered arm	Overall width	7 1/2	191
	Overall depth	30	762
	Overall height	30	762

Model	Upholstery / List (\$)	Other options (\$)
HA	Grade 1	457
	Grade 2	464
	Grade 3	473
	Grade 4	483
	Grade 5	492
	Grade 6	502
	Grade 7	512
	Grade 8	520

H-B153030

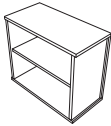

Description	Dimensions	(in)	(mm)
Bookcase	Overall width	15	381
	Overall depth	30	762
	Overall height	30	762

Model	List (\$)	Laminate finis
H-B153030	663	Specify code

HIP HOP JUNIOR

HJ24

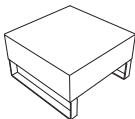

Description	Dimensions	(in)	(mm)
Square bench	Overall width	24	610
	Overall depth	24	610
	Overall height	14	356

Model	Frame	Upholstery / List (\$)	
HJ24	E8 Std	Grade 1	694
		Grade 2	699
	E9 N/C	Grade 3	705
		Grade 4	712
		Grade 5	718
		Grade 6	724
		Grade 7	730
		Grade 8	737

HJC24

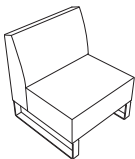

Description	Dimensions	(in)	(mm)	Dimensions	(in)	(mm)
Straight chair	Seat width	24	610	Overall width	24	610
	Seat depth	17	432	Overall depth	24	610
	Seat height	14	356	Overall height	28	711
	Back height	14	356			
	Back width	24	610			

Model	Frame	Upholstery / List (\$)	
HJC24	E8 Std	Grade 1	919
		Grade 2	924
	E9 N/C	Grade 3	931
		Grade 4	937
		Grade 5	943
		Grade 6	949
		Grade 7	955
		Grade 8	962

HJ48

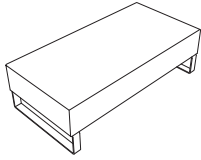

Description	Dimensions	(in)	(mm)
Rectangular bench	Overall width	48	1219
	Overall depth	24	610
	Overall height	14	356

Model	Frame	Upholstery / List (\$)
HJ48	E8 Std	Grade 1 1,144
		Grade 2 1,154
	E9 N/C	Grade 3 1,167
		Grade 4 1,180
	Grade 5 1,192	
	Grade 6 1,205	
	Grade 7 1,218	
	Grade 8 1,230	

HJC48

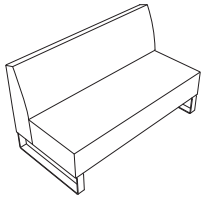

Description	Dimensions	(in)	(mm)	Dimensions	(in)	(mm)
Loveseat	Overall width	48	1219	Seat width	48	1219
	Overall depth	24	610	Seat depth	17	432
	Overall height	28	711	Seat height	14	356
	Back height	14	356			
	Back width	48	1219			

Model	Frame	Upholstery / List (\$)
HJC48	E8 Std	Grade 1 1,595
		Grade 2 1,607
	E9 N/C	Grade 3 1,623
		Grade 4 1,639
	Grade 5 1,654	
	Grade 6 1,670	
	Grade 7 1,685	
	Grade 8 1,701	

HJ2445

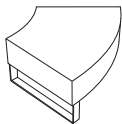

Description	Dimensions	(in)	(mm)	Dimensions	(in)	(mm)
Wedge bench Radius = 24" Degree = 45°	Seat width	41	1041	Overall width	41	1041
	Seat depth	24	610	Overall depth	31 ¾	806
	Seat height	14	356	Overall height	14	356

Model	Frame	Upholstery / List (\$)
HJ2445	E8 Std	Grade 1 1,119
		Grade 2 1,129
	E9 N/C	Grade 3 1,142
		Grade 4 1,154
	Grade 5 1,167	
	Grade 6 1,180	
	Grade 7 1,192	
	Grade 8 1,205	

HJ2445C

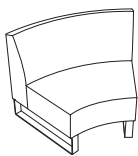

Description	Dimensions	(in)	(mm)	Dimensions	(in)	(mm)
Wedge chair Radius = 24" Degree = 45°	Seat width	32	813	Overall width	37	940
	Seat depth	17	432	Overall depth	26	661
	Seat height	14	356	Overall height	28	711
	Back height	14	356			
	Back width	34 ½	876			

Model	Frame	Upholstery / List (\$)
HJ2445C	E8 Std	Grade 1 1,395
		Grade 2 1,410
	E9 N/C	Grade 3 1,428
		Grade 4 1,447
	Grade 5 1,466	
	Grade 6 1,485	
	Grade 7 1,504	
	Grade 8 1,522	

HJC2445

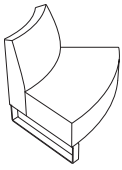

Description

Wedge chair
 Radius = 24"
 Degree = 45°

Dimensions

	(in)	(mm)
Seat width	32	813
Seat depth	17	432
Seat height	14	356
Back height	14	356
Back width	25 1/4	641

Dimensions

	(in)	(mm)
Overall width	37	940
Overall depth	26	661
Overall height	28	711

Model	Frame	Upholstery / List (\$)
HJC2445	E8 Std	Grade 1 1,395
	E9 N/C	Grade 2 1,410
		Grade 3 1,428
		Grade 4 1,447
		Grade 5 1,466
		Grade 6 1,485
		Grade 8 1,522

HIP HOP – SOLUTIONS

HOP – S1 \$58,356

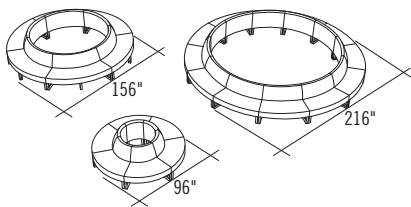

- 6 HC1860
- 6 HC4860
- 12 HC7830

HOP – S5 \$9,231

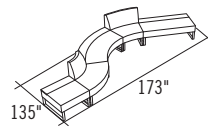

- 1 H30X
- 1 H60X
- 1 H1860X
- 1 HC1860
- 1 H4830C

HOP – S2 \$69,002

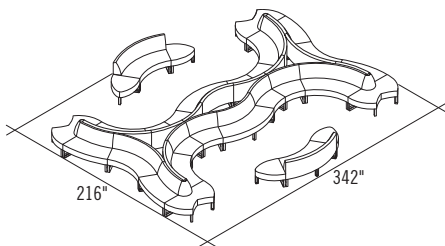

- 4 HO
- 4 HV
- 8 H4830C
- 8 H4860C
- 2 HC4860
- 4 H7830

HOP – S6 \$13,504

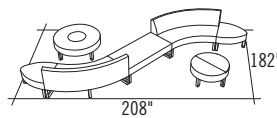

- 2 HO
- 1 H60
- 2 H4860C
- 1 H RTP48
- 1 H RTM36

HOP – S7 \$7,098

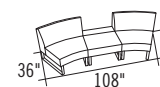

- 1 H30X
- 2 H4860C

HOP – S3 \$18,496

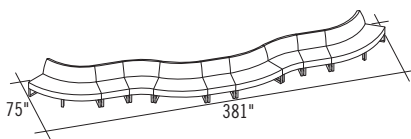

- 3 HC30
- 2 H4830C
- 2 H4860C
- 2 H7830

HOP – S8 \$13,020

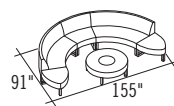

- 1 H4830C
- 2 H4860C
- 2 HO
- 1 H RTP48

HOP – S4 \$8,399

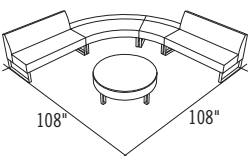

- 2 HC30
- 1 H4860X
- 1 H4830X
- 1 H RT36

HOP – S9 \$13,191

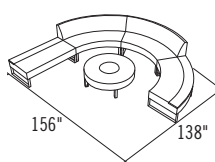

- 1 H60X
- 2 H4860C
- 1 H4860X
- 1 H RTP48

LOUNGE

SPECIFICATIONS

- All models ship assembled.
- Fabric/fabric, fabric/vinyl and vinyl/vinyl dual upholstery is available. The first upholstery code is the backrest and seat, the second upholstery code is for the arms.
- If dual upholstery combination is from two different grades, list price is the highest grade of the two.
- 5" height metal legs in aluminum finish.
- C.O.M./C.O.V.: please refer to page 54.

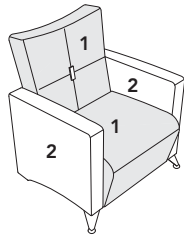

DUAL UPHOLSTERY APPLICATION

SAMPLE ORDER: LC1-ML-AM24-OL11-A



SAMPLE ORDER: LC1-ML-OL11-A

LC1



Description	Dimensions	(in)	(mm)	Dimensions	(in)	(mm)
Armchair	Seat width	21 ½	546	Overall width	31	787
Metal legs in front	Seat depth	20	508	Overall depth	32	813
	Seat height	19	483	Overall height	34	864
	Back height	20	508			

Model	Frame	Upholstery / List (\$)	Button (\$)
LC1	ML Std	Grade 1	1,682
		Grade 2	1,710
		Grade 3	1,744
		Grade 4	1,779
		Grade 5	1,813
		Grade 6	1,847
		Grade 7	2,945
		Grade 8	1,916
			A Std
			SA N/C

LOUNGE

SPECIFICATIONS

- All models ship assembled.
- Fabric/fabric, fabric/vinyl and vinyl/vinyl dual upholstery is available.
The first upholstery code is the backrest and arm structure, the second upholstery code is for the seat.
- If dual upholstery combination is from two different grades, list price is the highest grade of the two.
- Refer to page 59 for the 4 wood leg finishes available.
- C.O.M./C.O.V.: please refer to page 54.

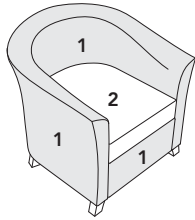

DUAL UPHOLSTERY APPLICATION

SAMPLE ORDER: MA1-W2-TN054-TN054

TN054 - TN054
1 2

SAMPLE ORDER: MA1-W2-TN054-TN054

MA1

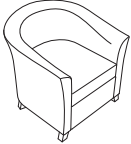

Description	Dimensions	(in)	(mm)	Dimensions	(in)	(mm)
Armchair	Seat width	20 ¼	514	Overall width	29 ½	750
Wooden legs	Seat depth	21	534	Overall depth	31	788
	Seat height	18	457	Overall height	31 ¾	807
	Back height	12	305			

Model	Frame	Upholstery / List (\$)
MA1	W1 Std	Grade 1 1,926
	W2 N/C	Grade 2 1,949
	W3 N/C	Grade 3 1,978
	W4 N/C	Grade 4 2,007
		Grade 5 2,036
		Grade 6 2,064
		Grade 7 2,991
		Grade 8 2,122



LOUNGE

SPECIFICATIONS

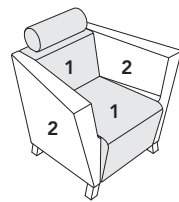
- All models ship assembled.
- Fabric/fabric, fabric/vinyl and vinyl/vinyl dual upholstery is available. The first upholstery code is the backrest and arm structure, the second upholstery code is for the seat.
- If dual upholstery combination is from two different grades, list price is the highest grade of the two.
- Headrest cannot be retrofitted on existing model.
- 16-gauge steel legs.
- C.O.M./C.O.V.: please refer to page 54.



DUAL UPHOLSTERY APPLICATION

SAMPLE ORDER: NA1-E9--

SAMPLE ORDER: NA1-E9-CE77-CE77

NA1

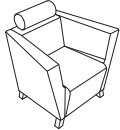

Description	Dimensions	(in)	(mm)	Dimensions	(in)	(mm)
Armchair	Seat width	21	533	Overall width	34 ¾	883
Metal legs	Seat depth	20 ¾	527	Overall depth	29	737
6"H headrest	Seat height	17 ½	445	Overall height	33 ¾	857
	Back height	10 ½	267			

Model	Frame	Upholstery / List (\$)	Other options (\$)
NA1	E8 Std	Grade 1 2,026	Grade 5 2,145
	E9 N/C	Grade 2 2,051	Grade 6 2,176
		Grade 3 2,083	Grade 7 3,069
		Grade 4 2,114	Grade 8 2,239
			HR Std

NA2

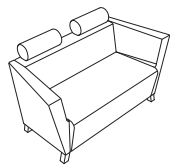

Description	Dimensions	(in)	(mm)	Dimensions	(in)	(mm)
Loveseat	Seat width	45	1143	Overall width	58 ¾	1492
Metal legs	Seat depth	20 ¾	527	Overall depth	29	737
6"H headrest	Seat height	17 ½	445	Overall height	33 ¾	857
	Back height	10 ½	267			

Model	Frame	Upholstery / List (\$)	Other options (\$)
NA2	E8 Std	Grade 1 2,627	Grade 5 2,841
	E9 N/C	Grade 2 2,672	Grade 6 2,897
		Grade 3 2,728	Grade 7 4,493
		Grade 4 2,784	Grade 8 3,009
			HR Std

NA3

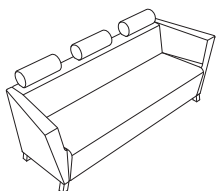

Description	Dimensions	(in)	(mm)	Dimensions	(in)	(mm)
Sofa	Seat width	69	1753	Overall width	82 ¾	2102
Metal legs	Seat depth	20 ¾	527	Overall depth	29	737
6"H headrest	Seat height	17 ½	445	Overall height	33 ¾	857
	Back height	10 ½	267			

Model	Frame	Upholstery / List (\$)	Other options (\$)
NA3	E8 Std	Grade 1 3,152	Grade 5 3,485
	E9 N/C	Grade 2 3,222	Grade 6 3,572
		Grade 3 3,310	Grade 7 6,050
		Grade 4 3,397	Grade 8 3,747
			HR Std

LOUNGE

SPECIFICATIONS

- All models ship assembled.
- Fabric/fabric, fabric/vinyl and vinyl/vinyl dual upholstery is available. The first upholstery code is for the seat, the second upholstery code is for the arms and structure.
- If dual upholstery combination is from two different grades, list price is the highest grade of the two.
- 14-gauge steel belt with 16-gauge legs.
- Please refer to your Lacasse Sampler for laminate choices for the Oly bench with storage LY2B and with shelf LY2T.
- C.O.M./C.O.V.: please refer to page 54.

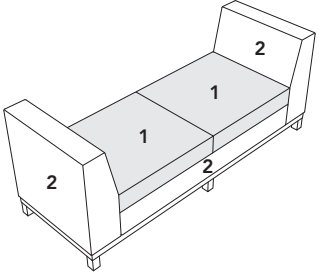

DUAL UPHOLSTERY APPLICATION

SAMPLE ORDER: LY2B-E8-SL24-GR909-TWT

SL24
1

GR909
2

SAMPLE ORDER: LY2B-E8-SL24-GR909-TWT

LY1

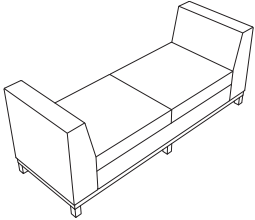

Description	Dimensions	(in)	(mm)	Dimensions	(in)	(mm)
Bench	Seat width	55	1397	Overall width	74	1880
	Seat depth	25	635	Overall depth	25	635
	Seat height	18	457	Overall height	31 ½	800
	Back height	13 ½	343			

Model	Frame	Upholstery / List (\$)			
LY1	E8 Std	Grade 1	2,158	Grade 5	2,312
	E9 N/C	Grade 2	2,190	Grade 6	2,353
		Grade 3	2,231	Grade 7	3,508
		Grade 4	2,271	Grade 8	2,434

LY2T

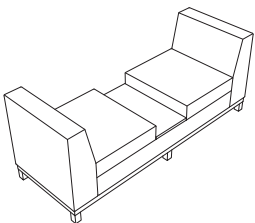

Description	Dimensions	(in)	(mm)	Dimensions	(in)	(mm)
Bench with integrated table	Seat width	55	1397	Overall width	74	1880
	Seat depth	25	635	Overall depth	25	635
	Seat height	18	457	Overall height	31 ½	800
	Back height	13 ½	343			

Model	Frame	Upholstery / List (\$)		Laminate finis	
LY2T	E8 Std	Grade 1	2,264	Grade 5	2,418
	E9 N/C	Grade 2	2,296	Grade 6	2,459
		Grade 3	2,337	Grade 7	3,493
		Grade 4	2,378	Grade 8	2,540
				Specify code	

LY2B

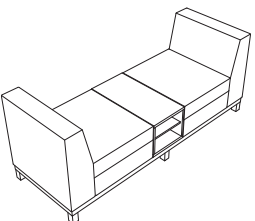

Description	Dimensions	(in)	(mm)	Dimensions	(in)	(mm)
Bench with integrated bookcase	Seat width	20 ½	521	Overall width	74	1880
	Seat depth	25	635	Overall depth	25	635
	Seat height	18	457	Overall height	31 ½	800
	Back height	13 ½	343			

Model	Frame	Upholstery / List (\$)		Laminate finis	
LY2B	E8 Std	Grade 1	2,364	Grade 5	2,518
	E9 N/C	Grade 2	2,397	Grade 6	2,559
		Grade 3	2,437	Grade 7	3,593
		Grade 4	2,478	Grade 8	2,640
				Specify code	

LOUNGE

SPECIFICATIONS

- All models ship assembled.
- Available in one-tone only.
- 4 ½" metal legs in aluminum finish for PF4, PF5 & PF6.
- C.O.M./C.O.V.: please refer to page 54.

SAMPLE ORDER: PF1-CY07

PF1



Description	Dimensions	(in)	(mm)
Round ottoman	Overall width	18	457
	Overall depth	18	457
	Overall height	17 ¼	438

Model	Upholstery / List (\$)
PF1	Grade 1 488
	Grade 2 495
	Grade 3 505
	Grade 4 514
	Grade 5 523
	Grade 6 533
	Grade 7 674
	Grade 8 552

PF2

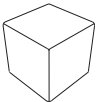

Description	Dimensions	(in)	(mm)
Square ottoman	Overall width	18	457
	Overall depth	18	457
	Overall height	17 ¼	438

Model	Upholstery / List (\$)
PF2	Grade 1 513
	Grade 2 522
	Grade 3 533
	Grade 4 543
	Grade 5 554
	Grade 6 565
	Grade 7 798
	Grade 8 587

PF3

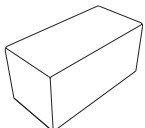

Description	Dimensions	(in)	(mm)
Rectangular ottoman	Overall width	36	915
	Overall depth	18	457
	Overall height	17 ¼	438

Model	Upholstery / List (\$)
PF3	Grade 1 644
	Grade 2 657
	Grade 3 672
	Grade 4 688
	Grade 5 704
	Grade 6 719
	Grade 7 1,061
	Grade 8 750

PF4



Description	Dimensions	(in)	(mm)
Round ottoman	Overall width	18	457
Aluminum legs	Overall depth	18	457
	Overall height	17 ¼	438

Model	Frame	Upholstery / List (\$)
PF4	ML Std	Grade 1 525
		Grade 2 533
		Grade 3 542
		Grade 4 552
		Grade 5 561
		Grade 6 570
		Grade 7 712
		Grade 8 589

PF5

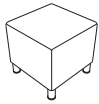

Description	Dimensions	(in)	(mm)
Square ottoman	Overall width	18	457
Aluminum legs	Overall depth	18	457
	Overall height	17 ¼	438

Model	Frame	Upholstery / List (\$)
PF5	ML Std	Grade 1 550
		Grade 2 559
		Grade 3 570
		Grade 4 581
		Grade 5 592
		Grade 6 603
		Grade 7 836
		Grade 8 625

PF6

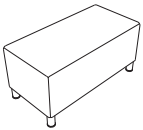

Description	Dimensions	(in)	(mm)
Rectangular ottoman	Overall width	36	915
Aluminum legs	Overall depth	18	457
	Overall height	17 ¼	438

Model	Frame	Upholstery / List (\$)
PF6	ML Std	Grade 1 682
		Grade 2 694
		Grade 3 710
		Grade 4 725
		Grade 5 741
		Grade 6 757
		Grade 7 1,099
		Grade 8 788

LOUNGE

SPECIFICATIONS

- All models ship assembled.
- Available in one-tone only.
- Refer to page 59 for the 4 wood leg finishes available.
- C.O.M./C.O.V.: please refer to page 54.

SAMPLE ORDER: SH3-W4-TN808

SH1

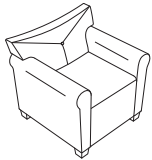

Description	Dimensions	(in)	(mm)	Dimensions	(in)	(mm)
Armchair	Seat width	23	533	Overall width	34 ½	876
Wooden legs	Seat depth	20 ½	584	Overall depth	30 ½	775
	Seat height	18	457	Overall height	31	787
	Back height	13	330			

Model	Frame	Upholstery / List (\$)	
SH1	W1 Std	Grade 1	1,795
		Grade 2	1,822
		Grade 3	1,857
		Grade 4	1,891
		Grade 5	1,926
		Grade 6	1,960
		Grade 7	2,936
		Grade 8	2,029

SH2

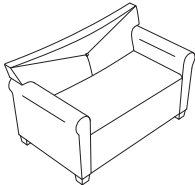

Description	Dimensions	(in)	(mm)	Dimensions	(in)	(mm)
Loveseat	Seat width	44	1118	Overall width	55	1397
Wooden legs	Seat depth	20 ½	584	Overall depth	30 ½	775
	Seat height	18	457	Overall height	31	787
	Back height	13	330			

Model	Frame	Upholstery / List (\$)	
SH2	W1 Std	Grade 1	2,333
		Grade 2	2,383
		Grade 3	2,445
		Grade 4	2,508
		Grade 5	2,570
		Grade 6	2,633
		Grade 7	4,407
		Grade 8	2,758

SH3

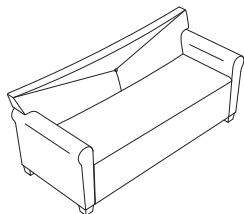

Description	Dimensions	(in)	(mm)	Dimensions	(in)	(mm)
Sofa	Seat width	66	1676	Overall width	77	1956
Wooden legs	Seat depth	20 ½	584	Overall depth	30 ½	775
	Seat height	18	457	Overall height	31	787
	Back height	13	330			

Model	Frame	Upholstery / List (\$)	
SH3	W1 Std	Grade 1	2,796
		Grade 2	2,868
		Grade 3	2,959
		Grade 4	3,049
		Grade 5	3,140
		Grade 6	3,231
		Grade 7	5,803
		Grade 8	3,412

LOUNGE

SPECIFICATIONS

- All models ship assembled.
- Fabric/fabric, fabric/vinyl and vinyl/vinyl dual upholstery is available. The first upholstery code is the backrest and arm structure, the second upholstery code is for the seat.
- If dual upholstery combination is from two different grades, list price is the highest grade of the two.
- Headrest cannot be retrofitted on existing model.
- 16-gauge steel legs.
- C.O.M./C.O.V.: please refer to page 54.

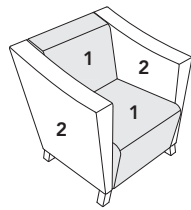

DUAL UPHOLSTERY APPLICATION

SAMPLE ORDER: SO2-E8-WH03-WH03

① ②

SAMPLE ORDER: SO2-E8-WH03-WH03

S01

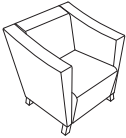

Description	Dimensions (in)	(mm)	Dimensions (in)	(mm)
Armchair	Seat width	21	30 ¾	781
Metal legs	Seat depth	20 ¾	30 ½	775
	Seat height	17 ½	31 ¾	807
	Back height	14 ¼		

Model	Frame	Upholstery / List (\$)	Other options (\$)
S01	E8 Std	Grade 1 1,814	HR 125
	E9 N/C	Grade 2 1,839	
		Grade 3 1,870	
		Grade 4 1,901	
		Grade 5 1,932	
		Grade 6 1,964	
		Grade 7 2,845	
		Grade 8 2,026	

S02

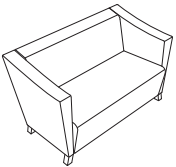

Description	Dimensions (in)	(mm)	Dimensions (in)	(mm)
Loveseat	Seat width	45	54 ¾	1391
Metal legs	Seat depth	20 ¾	30 ½	775
	Seat height	17 ½	31 ¾	807
	Back height	14 ¼		

Model	Frame	Upholstery / List (\$)	Other options (\$)
S02	E8 Std	Grade 1 2,364	HR 250
	E9 N/C	Grade 2 2,407	
		Grade 3 2,460	
		Grade 4 2,513	
		Grade 5 2,566	
		Grade 6 2,619	
		Grade 7 4,120	
		Grade 8 2,725	

S03

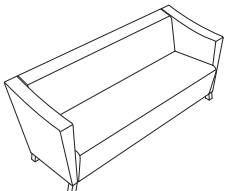

Description	Dimensions (in)	(mm)	Dimensions (in)	(mm)
Sofa	Seat width	69	78 ¾	2000
Metal legs	Seat depth	20 ¾	30 ½	775
	Seat height	17 ½	31 ¾	807
	Back height	14 ¼		

Model	Frame	Upholstery / List (\$)	Other options (\$)
S03	E8 Std	Grade 1 2,958	HR 375
	E9 N/C	Grade 2 3,018	
		Grade 3 3,093	
		Grade 4 3,168	
		Grade 5 3,243	
		Grade 6 3,318	
		Grade 7 5,450	
		Grade 8 3,468	

PUBLIC AREAS AND HEALTHCARE

SPECIFICATIONS

- All models ship assembled.
- Fabric/fabric, fabric/vinyl and vinyl/vinyl dual upholstery is available. The first upholstery code is the backrest and seat cushion, the second upholstery code is for the arms.
- If dual upholstery combination is from two different grades, list price is the highest grade of the two.
- 1" gap around seat cushion for ease of cleaning.
- 16-gauge steel base and belt.
- Levelers allow up to ¾" height adjustment.
- Please refer to your Lacasse Sampler for laminate choices.
- Please refer to accessories on page 53 for ganging brackets and floor anchors.
- C.O.M./C.O.V.: please refer to page 54.

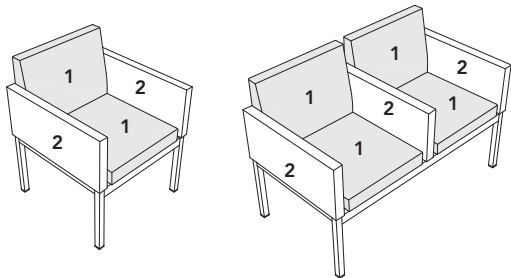

DUAL UPHOLSTERY APPLICATION

SAMPLE ORDER: TE2TR-E9-MG050-SL06-TWT

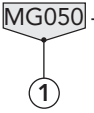

1

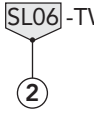

2

SAMPLE ORDER: TE2TR-E9-MG050-SL06-TWT

TE1

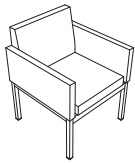

Description	Dimensions (in)	(mm)	Dimensions (in)	(mm)		
Armchair	Seat width	20 ½	521	Overall width	24 ½	622
	Seat depth	20	508	Overall depth	24 ½	622
	Seat height	18	457	Overall height	31	787
	Back height	13	330			

Model	Frame	Upholstery / List (\$)	
TE1	E8 Std	Grade 1	1,157
		Grade 2	1,173
	E9 N/C	Grade 3	1,193
		Grade 4	1,213
		Grade 5	1,233
		Grade 6	1,253
		Grade 7	1,816
		Grade 8	1,293

TE2

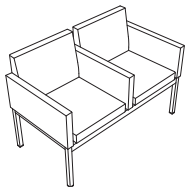

Description	Dimensions (in)	(mm)	Dimensions (in)	(mm)		
2-seat armchair	Seat width	20 ½	521	Overall width	47	1194
	Seat depth	20	508	Overall depth	24 ½	622
	Seat height	18	457	Overall height	31	787
	Back height	13	330			

Model	Frame	Upholstery / List (\$)	
TE2	E8 Std	Grade 1	1,864
		Grade 2	1,891
	E9 N/C	Grade 3	1,926
		Grade 4	1,960
		Grade 5	1,994
		Grade 6	2,029
		Grade 7	3,005
		Grade 8	2,098

TE2A

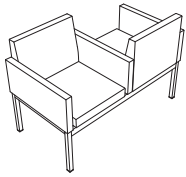

Description	Dimensions	(in)	(mm)	Dimensions	(in)	(mm)
2-seat armchair, alternating	Seat width	20 ½	521	Overall width	47	1194
	Seat depth	20	508	Overall depth	24 ½	622
	Seat height	18	457	Overall height	31	787
	Back height	13	330			

Model	Frame	Upholstery / List (\$)
TE2A	E8 Std	Grade 1 1,864
	E9 N/C	Grade 2 1,891
		Grade 3 1,926
		Grade 4 1,960
		Grade 5 1,994
		Grade 6 2,029
		Grade 7 3,005
		Grade 8 2,098

TE1TR

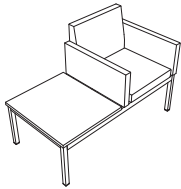

Description	Dimensions	(in)	(mm)	Dimensions	(in)	(mm)
Armchair, right-side table	Seat width	20 ½	521	Overall width	47	1194
	Seat depth	20	508	Overall depth	24 ½	622
	Seat height	18	457	Overall height	31	787
	Back height	13	330			

Model	Frame	Upholstery / List (\$)	Table finis
TE1TR	E8 Std	Grade 1 1,388	Specify laminate code
	E9 N/C	Grade 2 1,404	
		Grade 3 1,424	
		Grade 4 1,444	
		Grade 5 1,464	
		Grade 6 1,484	
		Grade 7 2,047	
		Grade 8 1,524	

TE1TL

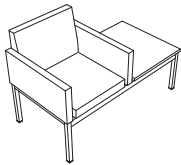

Description	Dimensions	(in)	(mm)	Dimensions	(in)	(mm)
Armchair, left-side table	Seat width	20 ½	521	Overall width	47	1194
	Seat depth	20	508	Overall depth	24 ½	622
	Seat height	18	457	Overall height	31	787
	Back height	13	330			

Model	Frame	Upholstery / List (\$)	Table finis
TE1TL	E8 Std	Grade 1 1,388	Specify laminate code
	E9 N/C	Grade 2 1,404	
		Grade 3 1,424	
		Grade 4 1,444	
		Grade 5 1,464	
		Grade 6 1,484	
		Grade 7 2,047	
		Grade 8 1,524	

TE3

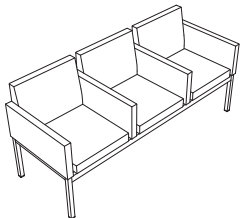

Description	Dimensions	(in)	(mm)	Dimensions	(in)	(mm)
3-seat armchair	Seat width	20 ½	521	Overall width	69 ½	1765
	Seat depth	20	508	Overall depth	24 ½	622
	Seat height	18	457	Overall height	31	787
	Back height	13	330			

Model	Frame	Upholstery / List (\$)
TE3	E8 Std	Grade 1 2,433
	E9 N/C	Grade 2 2,474
		Grade 3 2,525
		Grade 4 2,576
		Grade 5 2,628
		Grade 6 2,679
		Grade 7 4,134
		Grade 8 2,782

TE3A

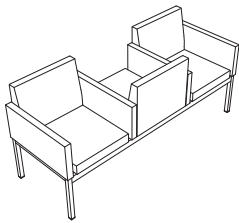

Description	Dimensions (in)	(mm)	Dimensions (in)	(mm)		
3-seat armchair, alternating	Seat width	20 ½	521	Overall width	69 ½	1765
	Seat depth	20	508	Overall depth	24 ½	622
	Seat height	18	457	Overall height	31	787
	Back height	13	330			

Model	Frame	Upholstery / List (\$)
TE3A	E8 Std	Grade 1 2,433
	E9 N/C	Grade 2 2,474
		Grade 3 2,525
		Grade 4 2,576
		Grade 5 2,628
		Grade 6 2,679
		Grade 7 4,134
		Grade 8 2,782

TE2TR

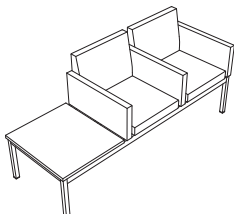

Description	Dimensions (in)	(mm)	Dimensions (in)	(mm)		
2-seat armchair, right-side table	Seat width	20 ½	521	Overall width	69 ½	1765
	Seat depth	20	508	Overall depth	24 ½	622
	Seat height	18	457	Overall height	31	787
	Back height	13	330			

Model	Frame	Upholstery / List (\$)	Table finis
TE2TR	E8 Std	Grade 1 2,151	Specify laminate code
	E9 N/C	Grade 2 2,179	
		Grade 3 2,213	
		Grade 4 2,248	
		Grade 5 2,282	
		Grade 6 2,316	
		Grade 7 3,293	
		Grade 8 2,385	

TE2TL

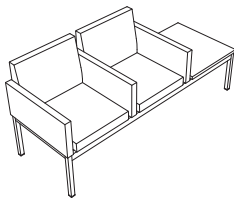

Description	Dimensions (in)	(mm)	Dimensions (in)	(mm)		
2-seat armchair, left-side table	Seat width	20 ½	521	Overall width	69 ½	1765
	Seat depth	20	508	Overall depth	24 ½	622
	Seat height	18	457	Overall height	31	787
	Back height	13	330			

Model	Frame	Upholstery / List (\$)	Table finis
TE2TL	E8 Std	Grade 1 2,151	Specify laminate code
	E9 N/C	Grade 2 2,179	
		Grade 3 2,213	
		Grade 4 2,248	
		Grade 5 2,282	
		Grade 6 2,316	
		Grade 7 3,293	
		Grade 8 2,385	

TE2TC

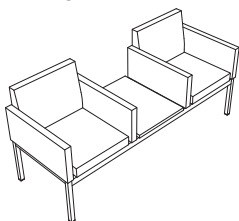

Description	Dimensions (in)	(mm)	Dimensions (in)	(mm)		
2-seat armchair, central table	Seat width	20 ½	521	Overall width	69 ½	1765
	Seat depth	20	508	Overall depth	24 ½	622
	Seat height	18	457	Overall height	31	787
	Back height	13	330			

Model	Frame	Upholstery / List (\$)	Table finis
TE2TC	E8 Std	Grade 1 2,151	Specify laminate code
	E9 N/C	Grade 2 2,179	
		Grade 3 2,213	
		Grade 4 2,248	
		Grade 5 2,282	
		Grade 6 2,316	
		Grade 7 3,293	
		Grade 8 2,385	

TE01

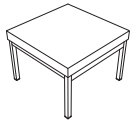

Description	Dimensions	(in)	(mm)
Ottoman	Overall width	24 ½	622
	Overall depth	24 ½	622
	Overall height	18	457

Model	Frame	Upholstery / List (\$)
TE01	E8 Std	Grade 1 619
		Grade 2 623
	E9 N/C	Grade 3 628
		Grade 4 632
		Grade 5 637
		Grade 6 642
		Grade 7 729
		Grade 8 651

TE02

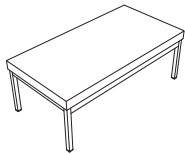

Description	Dimensions	(in)	(mm)
2-seat ottoman	Overall width	47	1194
	Overall depth	24 ½	622
	Overall height	18	457

Model	Frame	Upholstery / List (\$)
TE02	E8 Std	Grade 1 944
		Grade 2 962
	E9 N/C	Grade 3 984
		Grade 4 1,006
		Grade 5 1,028
		Grade 6 1,049
		Grade 7 1,164
		Grade 8 1,093

TE03

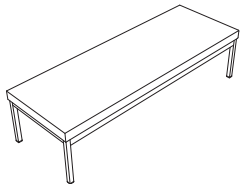

Description	Dimensions	(in)	(mm)
3-seat ottoman	Overall width	69 ½	1765
	Overall depth	24 ½	622
	Overall height	18	457

Model	Frame	Upholstery / List (\$)
TE03	E8 Std	Grade 1 1,245
		Grade 2 1,271
	E9 N/C	Grade 3 1,304
		Grade 4 1,336
		Grade 5 1,369
		Grade 6 1,402
		Grade 7 1,574
		Grade 8 1,468

TE-T2424

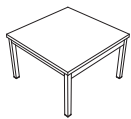

Description	Dimensions	(in)	(mm)
Square table	Overall width	24 ½	622
	Overall depth	24 ½	622
	Overall height	15 ½	394

Model	Frame	List (\$)	Table finis
TE-T2424	E8 Std	657	Specify code
	E9 N/C		

TE-T2448

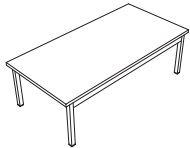

Description	Dimensions	(in)	(mm)
Rectangular table	Overall width	47	1194
	Overall depth	24 ½	622
	Overall height	15 ½	394

Model	Frame	List (\$)	Table finis
TE-T2448	E8 Std	857	Specify laminate code
	E9 N/C		

Available solutions for Terra are the same as for Zeta. See page 52 for details.

PUBLIC AREAS

SPECIFICATIONS

- All models ship assembled.
- Fabric/fabric, fabric/vinyl and vinyl/vinyl dual upholstery is available. The first upholstery code is the backrest and seat cushion, the second upholstery code is for the arms.
- If dual upholstery combination is from two different grades, list price is the highest grade of the two.
- 16-gauge steel base and belt.
- Levelers allow up to ¾" height adjustment.
- Please refer to your Lacasse Sampler for laminate choices.
- Please refer to accessories on page 53 for ganging brackets and floor anchors.
- C.O.M./C.O.V.: please refer to page 54.

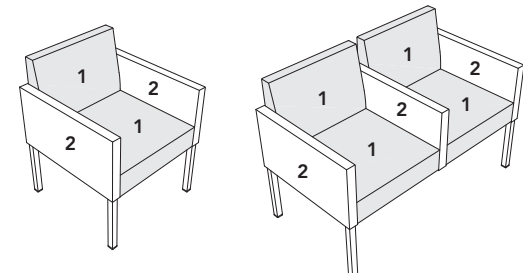

DUAL UPHOLSTERY APPLICATION

SAMPLE ORDER: ZE1-E8-AM24-AM47



1



2

SAMPLE ORDER: ZE1-E8-AM24-AM47

ZE1

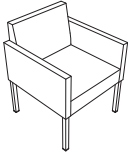

Description	Dimensions	(in)	(mm)	Dimensions	(in)	(mm)
Armchair	Seat width	20 ½	521	Overall width	24 ½	622
	Seat depth	20	508	Overall depth	24 ½	622
	Seat height	18	457	Overall height	31	787
	Back height	13	330			

Model	Frame	Upholstery / List (\$)
ZE1	E8 Std	Grade 1 1,157
		Grade 2 1,173
	E9 N/C	Grade 3 1,193
		Grade 4 1,213
		Grade 5 1,233
		Grade 6 1,253
		Grade 7 1,816
		Grade 8 1,293

ZE2

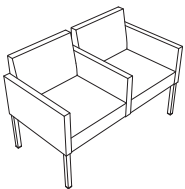

Description	Dimensions	(in)	(mm)	Dimensions	(in)	(mm)
2-seat armchair	Seat width	20 ½	521	Overall width	47	1194
	Seat depth	20	508	Overall depth	24 ½	622
	Seat height	18	457	Overall height	31	787
	Back height	13	330			

Model	Frame	Upholstery / List (\$)
ZE2	E8 Std	Grade 1 1,864
		Grade 2 1,891
	E9 N/C	Grade 3 1,926
		Grade 4 1,960
		Grade 5 1,994
		Grade 6 2,029
		Grade 7 3,005
		Grade 8 2,098

ZE2A

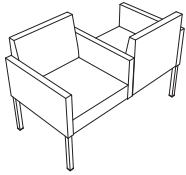

Description	Dimensions	(in)	(mm)	Dimensions	(in)	(mm)
2-seat armchair, alternating	Seat width	20 ½	521	Overall width	47	1194
	Seat depth	20	508	Overall depth	24 ½	622
	Seat height	18	457	Overall height	31	787
	Back height	13	330			

Model	Frame	Upholstery / List (\$)
ZE2A	E8 Std	Grade 1 1,864
	E9 N/C	Grade 2 1,891
		Grade 3 1,926
		Grade 4 1,960
		Grade 5 1,994
		Grade 6 2,029
		Grade 7 3,005
		Grade 8 2,098

ZE1TR

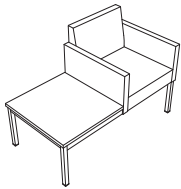

Description	Dimensions	(in)	(mm)	Dimensions	(in)	(mm)
1-seat armchair, right-side table	Seat width	20 ½	521	Overall width	47	1194
	Seat depth	20	508	Overall depth	24 ½	622
	Seat height	18	457	Overall height	31	787
	Back height	13	330			

Model	Frame	Upholstery / List (\$)	Table finis
ZE1TR	E8 Std	Grade 1 1,388	Specify laminate code
	E9 N/C	Grade 2 1,404	
		Grade 3 1,424	
		Grade 4 1,444	
		Grade 5 1,464	
		Grade 6 1,484	
		Grade 7 2,047	
		Grade 8 1,524	

ZE1TL

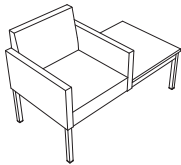

Description	Dimensions	(in)	(mm)	Dimensions	(in)	(mm)
1-seat armchair, left-side table	Seat width	20 ½	521	Overall width	47	1194
	Seat depth	20	508	Overall depth	24 ½	622
	Seat height	18	457	Overall height	31	787
	Back height	13	330			

Model	Frame	Upholstery / List (\$)	Table finis
ZE1TL	E8 Std	Grade 1 1,388	Specify laminate code
	E9 N/C	Grade 2 1,404	
		Grade 3 1,424	
		Grade 4 1,444	
		Grade 5 1,464	
		Grade 6 1,484	
		Grade 7 2,047	
		Grade 8 1,524	

ZE3

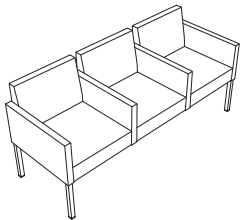

Description	Dimensions	(in)	(mm)	Dimensions	(in)	(mm)
3-seat armchair	Seat width	20 ½	521	Overall width	69 ½	1765
	Seat depth	20	508	Overall depth	24 ½	622
	Seat height	18	457	Overall height	31	787
	Back height	13	330			

Model	Frame	Upholstery / List (\$)
ZE3	E8 Std	Grade 1 2,433
	E9 N/C	Grade 2 2,474
		Grade 3 2,525
		Grade 4 2,576
		Grade 5 2,628
		Grade 6 2,679
		Grade 7 4,134
		Grade 8 2,782

ZE3A

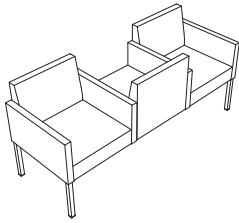

Description	Dimensions (in)	(mm)	Dimensions (in)	(mm)		
3-seat armchair, alternating	Seat width	20 ½	521	Overall width	69 ½	1765
	Seat depth	20	508	Overall depth	24 ½	622
	Seat height	18	457	Overall height	31	787
	Back height	13	330			

Model	Frame	Upholstery / List (\$)
ZE3A	E8 Std	Grade 1 2,433
	E9 N/C	Grade 2 2,474
		Grade 3 2,525
		Grade 4 2,576
		Grade 5 2,628
		Grade 6 2,679
		Grade 7 4,134
		Grade 8 2,782

ZE2TR

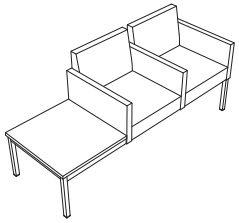

Description	Dimensions (in)	(mm)	Dimensions (in)	(mm)		
2-seat armchair, right-side table	Seat width	20 ½	521	Overall width	69 ½	1765
	Seat depth	20	508	Overall depth	24 ½	622
	Seat height	18	457	Overall height	31	787
	Back height	13	330			

Model	Frame	Upholstery / List (\$)	Table finis
ZE2TR	E8 Std	Grade 1 2,151	Specify laminate code
	E9 N/C	Grade 2 2,179	
		Grade 3 2,213	
		Grade 4 2,248	
		Grade 5 2,282	
		Grade 6 2,316	
		Grade 7 3,293	
		Grade 8 2,385	

ZE2TL

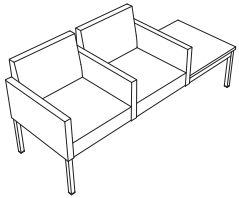

Description	Dimensions (in)	(mm)	Dimensions (in)	(mm)		
2-seat armchair, left-side table	Seat width	20 ½	521	Overall width	69 ½	1765
	Seat depth	20	508	Overall depth	24 ½	622
	Seat height	18	457	Overall height	31	787
	Back height	13	330			

Model	Frame	Upholstery / List (\$)	Table finis
ZE2TL	E8 Std	Grade 1 2,151	Specify laminate code
	E9 N/C	Grade 2 2,179	
		Grade 3 2,213	
		Grade 4 2,248	
		Grade 5 2,282	
		Grade 6 2,316	
		Grade 7 3,293	
		Grade 8 2,385	

ZE2TC

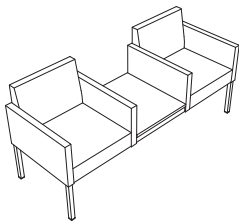

Description	Dimensions (in)	(mm)	Dimensions (in)	(mm)		
2-seat armchair, central table	Seat width	20 ½	521	Overall width	69 ½	1765
	Seat depth	20	508	Overall depth	24 ½	622
	Seat height	18	457	Overall height	31	787
	Back height	13	330			

Model	Frame	Upholstery / List (\$)	Table finis
ZE2TC	E8 Std	Grade 1 2,151	Specify laminate code
	E9 N/C	Grade 2 2,179	
		Grade 3 2,213	
		Grade 4 2,248	
		Grade 5 2,282	
		Grade 6 2,316	
		Grade 7 3,293	
		Grade 8 2,385	

ZE01

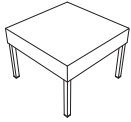

Description	Dimensions	(in)	(mm)
Ottoman	Overall width	24 ½	622
	Overall depth	24 ½	622
	Overall height	18	457

Model	Frame	Upholstery / List (\$)
ZE01	E8 Std	Grade 1 619
	E9 N/C	Grade 2 623
		Grade 3 628
		Grade 4 632
		Grade 5 637
		Grade 6 642
		Grade 7 729
		Grade 8 651

ZE02

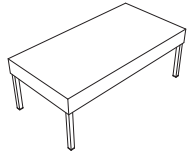

Description	Dimensions	(in)	(mm)
2-seat ottoman	Overall width	47	1194
	Overall depth	24 ½	622
	Overall height	18	457

Model	Frame	Upholstery / List (\$)
ZE02	E8 Std	Grade 1 944
	E9 N/C	Grade 2 952
		Grade 3 961
		Grade 4 971
		Grade 5 980
		Grade 6 989
		Grade 7 1,164
		Grade 8 1,008

ZE03

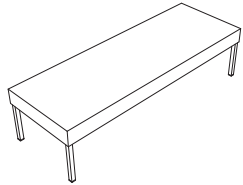

Description	Dimensions	(in)	(mm)
3-seat ottoman	Overall width	69 ½	1765
	Overall depth	24 ½	622
	Overall height	18	457

Model	Frame	Upholstery / List (\$)
ZE03	E8 Std	Grade 1 1,245
	E9 N/C	Grade 2 1,256
		Grade 3 1,270
		Grade 4 1,284
		Grade 5 1,298
		Grade 6 1,312
		Grade 7 1,574
		Grade 8 1,340

ZETA AND TERRA – SOLUTIONS

Replace the "Z" by a "T" at the beginning of each model number to switch to Terra solutions.

ZETA – S1 \$2,971

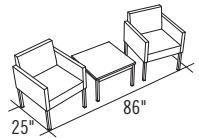

- 2 ZE1
- 1 TE-T2424

ZETA – S3 \$12,979

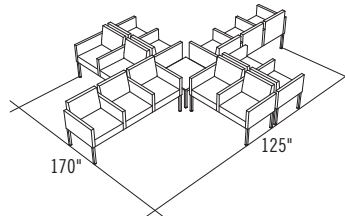

- 4 ZE2
- 2 ZE3
- 1 TE-T2424

ZETA – S2 \$4,015

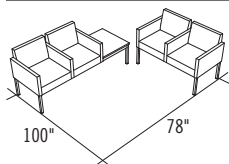

- 1 ZE2
- 1 ZE2TL

ZETA – S4 \$4,641

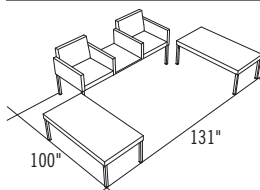

- 4 ZE2TC
- 2 ZE03

ACCESSORIES

GANG2

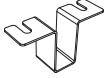

Description

Ganging device for Cube 200
Includes 2 ganging devices with hardware
Can gang 2 modules together

Model	List (\$)
GANG2	35

GANG3

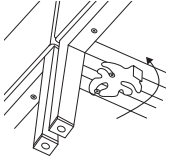

Description

Ganging device for Aerial, Cube 300, Hip Hop, Terra and Zeta
Includes 2 ganging devices with hardware
Can gang 2 modules together

Model	List (\$)
GANG3	35

FIX2

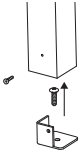

Description

Floor anchors for Cube 200
Includes 2 anchors
Can anchor 2 legs on floor

Model	List (\$)
FIX2	35

FIX3

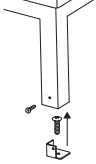

Description

Floor anchors for Aerial, Cube 300, Terra and Zeta
Includes 2 anchors
Can anchor 2 legs on floor

Model	List (\$)
FIX3	35

C.O.M./C.O.V. Policy

Fabric approval

All C.O.M./C.O.V. materials must be approved for use by Groupe Lacasse/Arold manufacturing facilities. In order to determine pre-approval, please contact the C.O.M./C.O.V. coordinator at 1-888-522-2773.

To solicit approval, 2 samples (minimum of 8" × 8") need to be forwarded to below address along with the material's specifications to the attention of the C.O.M./C.O.V. coordinator. If California # 117 compliant, the certification must accompany the material. Please ensure that the custom fabric form is completely filled out and sent to the C.O.M./C.O.V. coordinator or the test cannot be processed. The ORIENTATION section is especially important; if it fails to be completed the material will be applied as it comes off the roll.

Groupe Lacasse/Arold

C/O COM Coordinator
147, Saint-Pierre St
Saint-Pie, QC J0H 1W0
Canada

Once the C.O.M./C.O.V. material has been tested, you will be contacted by the C.O.M./C.O.V. coordinator with the results. Upon approval, you will be directed as to any additional yardage requirements beyond the published C.O.M./C.O.V. yardage. To determine amount of upholstery needed, please refer to the C.O.M./C.O.V. designation (model specific) in the login section section of the website (www.groupelacasse.com). Yardage is based on 54" width roll. Some directional or railroaded material may require additional yardage.

All materials are to be received from the vendor clearly marked with your purchase order number, VENDOR-PATTERN-COLOR and quantity of yards. There should not be more than one piece per roll. Back orders or partial shipments will not be accepted. Rolls must not exceed 50 lbs. All C.O.M./C.O.V. material must be shipped prepaid to our manufacturing facility. DO NOT ship C.O.M./C.O.V. material without positive test results.

Once approved, please forward your purchase order to the C.O.M./C.O.V. coordinator (fax: 1-888-248-1865) and the upholstery to the specified address. Surplus material, unused material or material that cannot be identified will be discarded after 60 days. C.O.M./C.O.V. upholstery is subject to final approval upon arrival. It is the responsibility of the customer or customer's vendor to inspect material for bias and/or flaws prior to shipment to Groupe Lacasse/Arold.

Disclaimer

The Seller reserves the right to approve all C.O.M./C.O.V. prior to acceptance. Even after preliminary approval, the Seller reserves the right to reject C.O.M./C.O.V. if tests or early production results indicate the material will not meet the Seller's quality standards or excessive unforeseen costs will be incurred. For accepted C.O.M./C.O.V., the Seller assumes no responsibility for its appearance, quality, durability, colorfastness or any other attributes after application to a Arold product. The Seller will determine any additional yardage, labor charges or surcharges that may be required as a condition of C.O.M./C.O.V. acceptance.

Purchase orders will not be processed until material has been approved and production cannot be scheduled until upholstery has been received. Upon completing these steps, your ship date will be determined. The Seller may split an order at the customer's request and may be subject to a minimum order charge.

The Seller is not responsible for excess C.O.M./C.O.V. from completed orders unless express agreement has been reached in advance. The customer is responsible for the return of any excess material. C.O.M./C.O.V. orders may not be changed or cancelled after acknowledgement.

Please consult the C.O.M./C.O.V. coordinator (1-888-522-2773) with any questions regarding this process.

Pricing

C.O.M. (FABRIC): is priced at Grade 2.

C.O.V. (VINYL): is priced at Grade 3.

For internal use only

Tracking #

Date



Custom Fabric Form

All information below needs to be supplied in order to process your request and two test swatches (minimum 8" x 8") must be sent. Additional material may be requested. Please include this form and a Cal-117 certification (if applicable) to all test requests. If fabric is reversible, please indicate up side with a color swatch. Remember that fabric (C.O.M.) is priced at grade 2 and vinyl (C.O.V.) is priced at grade 3. Contact the C.O.M. coordinator with any questions.

Please fax this form to Arold C.O.M./C.O.V. coordinator at 1-888-248-1865 (send only if testing is required).

General information

Date of request	Bill to address
Customer name	
Contact person	
Phone	
Email address	

Textile information

Test #	Results		Supplier	Pattern name	Pattern #	Colour
	Passed	Failed				
1.						
2.						
3.						
4.						
5.						

For internal use only

	Please check		Orientation		Reversible fabric?		Is fabric Cal-117?		Backer type
	Fabric	Vinyl	Off the roll	Railroaded	Yes	No	Yes	No	(If applicable)
1.									
2.									
3.									
4.									
5.									

Other comments

Terms and Conditions

Order placement

Groupe Lacasse* requires that all orders must be submitted in writing as represented by a valid purchase order on company letterhead, which includes the total list and net dollars. This is to ensure that orders are complete, to avoid errors, and to avoid duplication. Please order product by number in order to avoid any possible error. Telephone orders will not be processed for production without proper written confirmation. Groupe Lacasse* will not be responsible for errors, omissions and order duplication due to non-compliance with this procedure.

Ordering information

The following information is required to process an order:

Customer information

Sold/Ship to address
Purchase order number
Authorized signature
Contact name and phone
Consignee contact name and phone
Tagging instructions
Bid/Quote # if applicable
Product pricing (list/net)
Order total (list/net)
Preferred delivered date
(specific delivery date not guaranteed)

Product information

Quantity
Product numbers including options
Fabric and colours (all surfaces)

Order changes

Any change to an original purchase order must be received in writing no later than 48 hours after receipt of the original order. Any change to the original order after 48 hours, if approved, will result in production rescheduling. The cost variances will have to be approved by our Customer Service before production rescheduling.

Order cancellations

Cancellations must be requested in writing no later than 48 hours after receipt of the original order and are subject to approval by Groupe Lacasse*. Cancellations cannot be accepted otherwise.

Order acknowledgment

Orders will be acknowledged by Groupe Lacasse*. Please refer to the acknowledgment copy to make sure it agrees with your original purchase order. When corresponding, please refer to the acknowledgment number.

Returns

Products are made-to-order and may not be cancelled or returned. For warranty issues, please contact Customer Service. The Seller reserves the right to recall any defective items for evaluation.

Surcharges

Expedited Transportation

No shipments have guaranteed delivery time and/or date. Time-sensitive deliveries that require expedited carrier service will result in additional charges that will be passed on to the consignee (dealer).

Prices

All prices listed are suggested retail prices, F.C.A. destination. Orders are accepted subject to prices and taxes prevailing at the time of shipment. Prices and taxes are subject to change without notice. If shipping date requested is more than 90 days from date of order, Groupe Lacasse* shall have the right to use the published list prices effective at the time of shipment.

Chargeable Parts Orders

Contact customer service for availability. Orders under \$25 are subject to a \$20 minimum parts order charge. The small order charge does not apply to replacement parts orders. Service parts prices are subject to change without notice or approval. Price list dated January 5, 2015 supersedes all other published price lists. Prices shown in price book have priority to electronic catalog contents.

Terms

Terms of sale are net 30 days to firms who have established satisfactory credit; otherwise we reserve the right to request cash in advance. Interest on past due accounts shall be 2% per month (24% per year). Should the Buyer fail to fulfill the above-mentioned terms of payment, Groupe Lacasse* reserves the right to defer further shipments until the Buyer has satisfied all solvency criteria and terms of payment as determined by Groupe Lacasse*. Any product sold shall remain the property of Groupe Lacasse* and shall remain the Seller's property until paid for in full. The Buyer agrees to perform all acts which may be necessary to protect and assure retention of title to such products by Groupe Lacasse* until such time as goods have been paid for in full.

Credit

Credit may be established for sales on open account by submitting satisfactory references. A line of credit will be set by our credit department. We may change or cancel credit terms at our discretion and request advance payment at our option. A delay in providing credit information may delay order entry and the shipping date of an order. The Seller reserves the right to delay or cancel any shipment to a customer whose account balance is over the credit limit and/or past due. We do not ship C.O.D. Inactive account of more than one (1) year will result in a reevaluation of the account.

Applicable prices

List prices and discounts are subject to change without notice or approval. Applicable prices are those in effect at the time of the receipt of an order; we reserve the right to use the published list prices effective at the time of shipment if the requested ship date is more than 90 days after the order receipt date. Prices shown in price book have priority to electronic catalog contents.

Services

List prices apply to products only. If, as a result of customer request, the dealer or authorized representative provides planning/design services, storage, special handling, set-up, or installation, the customer will be charged at the local dealer or authorized representative's standard rate.

Quotations

Quotations are valid for a period of thirty (30) days.

Changes

All illustrations, specifications and prices in this book are based on the latest product information available at the time of publication. The right is reserved to make changes, at any time and without prior notice, to prices, colours, materials, specifications and models offered.

Delivery

The scheduled delivery week is specified on our acknowledgment. Groupe Lacasse* is not liable for delay or failure to deliver goods due to causes beyond its control. Groupe Lacasse* will only make on site deliveries for a half truck (1200 square feet). An unloading dock must be available to accommodate 53 feet trailers and address is subject to approval. Unloading at destination is the responsibility of the purchaser. Our standard carriers do not have liftgates. Request for liftgates can often be accommodated with a minimum notice of 2 weeks but will result in extra fees. Time sensitive deliveries that require expedited carrier service will result in additional charges that will be passed onto the consignee (dealer). Under no circumstance will Groupe Lacasse deliver goods in a residential area. Groupe Lacasse cannot accommodate inside deliveries.

Ship dates and delays

If the Seller cannot ship products due to causes beyond its reasonable control (such as casualty, acts of nature, labor disputes, or accident; inability to obtain necessary labor, material or transportation; changes requested by the customer), the ship date will be extended to compensate for the delay as determined by the Seller.

Routing

Unless otherwise specified by the buyer and agreed to by Groupe Lacasse*, the latter reserves the right to select the route, method of shipment and carrier. Customer requests for special carrier, method of shipment and/or routing will be shipped freight collect.

Transportation policy

This map is for Groupe Lacasse's US market deliveries.

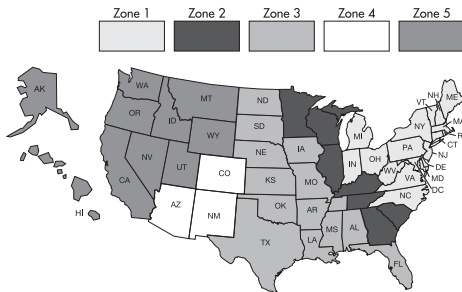

"Zone 0" shipments are FCA plant.

"Zone 1", "Zone 2", "Zone 3", "Zone 4" and "Zone 5" pricing includes freight cost to your geographical location.

On orders less than \$2,000 net (regardless of brand and/or shipping point) we will add a \$50 small order fee in "Zone 1". For "Zone 2", "Zone 3", "Zone 4" and "Zone 5", the small order fee is \$100.

Orders under \$25 net are subject to a \$20 small order fee (instead of 50\$ or 100\$) regardless of the shipping zone.

Freight charges beyond the continental United States are the purchaser's responsibility. Shipments beyond the continental United States must deliver to a freight forwarder or forwarding carrier of your choice. It is the customer's responsibility to provide this information on purchase orders.

Storage

In the event the purchaser request postponement of shipment beyond the scheduled shipping week after the goods have become work in process, or are ready to be shipped, Groupe Lacasse* can take arrangements to store the goods but at the purchaser's risk and expense. Such transfer to storage shall be deemed delivery to purchaser for all purposes including invoicing and payment.

Freight claims

All FCA destination claims will be handled and filed by the Seller. In order to expedite any credit due, your help and assistance is required. Please adhere to the following guidelines. The merchandise is carefully packed and thoroughly inspected before leaving the warehouse. Responsibility for its safe delivery is assumed by the carrier upon acceptance of the shipment. Claims for loss or damage sustained in transit must therefore be made to Groupe Lacasse* as follows:

A. Concealed loss or damage

Concealed loss or damage means loss or damage that does not become apparent until the merchandise has been unpacked. The contents may be damaged in transit due to rough handling even though the carton may not show external damage. When damage is discovered upon unpacking, a written request must be made to Groupe Lacasse Customer Service within 15 days of the receiving date. No disposition will be taken until approved by the manufacturer.

IMPORTANT: Groupe Lacasse's policy in concealed damage is to replace the part or complete product if necessary at no charge to the dealer. However, it is the responsibility of the dealer to provide installation of the replaced part or complete product. Therefore, no labor fees will be accepted on concealed damages.

B. Visible damage or shortage

Any external evidence of damage or shortage must be noted on the freight bill or express receipts and signed by the carrier's agent. Failure to adequately describe such external evidence of damage or shortage may result in refusing to honor a damage claim. When damage or shortage is discovered, a written request must be made to Groupe Lacasse Customer Service within 5 days of the receiving date.

For claims, please contact **Groupe Lacasse Customer Service** by phone at **1-888-522-2773**, by fax at **1-888-248-1865** or by email at LacasseCustomerservice@groupelacasse.com.

Product

A. Use and installation of products

The Seller recommends that its products be installed according to its written installation procedures. The customer agrees to use the Seller's products properly; not to remove or alter safety devices, warnings, or operation instructions placed on products by the Seller and to instruct employees as to the proper care and use of the products according to printed instructions. Installers can be contracted through one of the Seller's dealer or affiliate on a separately negotiated basis.

B. Service

Service requests for design, installation, relocation, storage, trade-in, etc. are handled by the local authorized dealer. Contact the local authorized dealer for more details.

C. Design

We reserve the right to make changes in product offering, design and materials as well as discontinuance of parts and units when such action is deemed to be an improvement in design or function.

**To lighten the text, the term Groupe Lacasse here is meant to include Groupe Lacasse LLC (US market) and Groupe Lacasse Inc. (Canadian market).*

Warranty

The following warranty applies to Arold products manufactured after January 5, 2015. This warranty is given to the initial buyer and is valid for as long as the product is owned by the original buyer. The warranty, which runs from the date of manufacture, covers defects in materials and craftsmanship found during normal usage of products during the applicable warranty period.

Warranty:

Groupe Lacasse LLC warrants its products, from the date of invoice, to be free from defects in material and workmanship for as long as the original purchaser owns it; proof of delivery being the only official document accepted by Groupe Lacasse LLC for any claim. This warranty is subject to the limitations, exclusions and other provisions below: Lifetime except those listed below. Weight limit: 250 lbs. (141 kg).

Arold Products	Applicable Warranty Period
C.O.M./C.O.V./SPL/ Lacasse To Supply Material Program:	Not warranted
Casters/Glides	5 years
Electrical components	5 years
Exposed wood	2 years
Foam	5 years
High-performance thermofused laminate	25 years
Internal wood frame	Lifetime
Metal frames	Lifetime
Standard upholstery and Graded-in	5 years
Workmanship	10 years

Labor, delivery charges and service not covered under warranty.

This warranty does not apply to “normal wear and tear”, abuse, damage caused by a carrier, damaged caused by transport of product from one site or location to another and alterations to the product not expressly authorized by the Seller. It also does not apply to “Customer’s Own Material”, “Lacasse – To Supply Material” and “SPL” fabric, (i.e., material specified by the buyer that is not a standard Arold product offering) used in the manufacture of Arold products. The Seller does not warrant the matching of colour, grain or texture except to within commercially acceptable standards. For the purposes of warranty claims, upholstery fabrics that have been dropped from Arold stocked fabric program will be supported for 6 months from the date of discontinuation. For fabrics that are no longer available from the manufacturer, substitute fabrics will be used for warranty claims.

A product will not be considered defective, and it will not be subject to the warranty, if the product is not installed or used as recommended in the Seller’s written planning, installation or user guides. The warranty does not apply to any Arold seating product that is used by an individual weighing over 250 lbs. (113 kg). Warranty will be void if identification label is removed under the chair or if a proof of purchase cannot be supplied, such as an order number or an invoice.

Except as stated above, the Seller does not make any express or implied warranties as to any product and in particular does not make any warranty of fitness for any particular purpose except for standard use of no more than 40 hours per week. The remedies described above are the buyer’s exclusive remedies for any product defect. The Seller shall not be liable for consequential, economic, indirect, punitive or incidental damages arising from any product defect.

* The applicable warranty period assumes that the product is used an average of not more than 40 hours per week. If a product is used more than this, the applicable warranty period shall be reduced in proportion to the increased usage. For example, if casters are used an average of 50 hours per week, the applicable warranty period for the casters shall be reduced to four years.

Lacasse thermofused laminate finishe

ACA – Mahogany	CER – Cherry	FOS – Fossil	GVR – Frost	NTL – Natural Cherry	TWT – Tuscany Walnut
BUC – Bourbon Cherry	CLY – Clay	GAN – Anthracite Grey	HZN – Hazelnut	PCM – Parchment	WGR – Willow Grey
CAR – Caramello	DCH – Dark Chocolate	GGI – Grigio	NCN – Crystal Black	RBY – Ruby	
CCL – Classic Chocolate	ERH – Hard Rock Maple	GIN – Ginger	NRM – Natural Maple	SNO – Snow	

Arold wood finishe

W1 – Tobacco Cherry	W2 – Cherry	W3 – Shadow Oak	W4 – Natural
----------------------------	--------------------	------------------------	---------------------

Sample order

A With button	CSW Contrast stitching, white	HR Headrest	TAL Tablet arm on left (<i>while seated</i>)
SA Without button	DH 3" higher back	PC Electrical/Communication module	TAR Tablet arm on right (<i>while seated</i>)
CSB Contrast stitching, black	HDW Hard dual wheel casters	SDW Soft dual wheel casters	ML Metal legs



Aroid

CONTRACT • CONTRAT

A GROUPE LACASSE BRAND

GROUPE
LACASSE

1 888 522.2773 www.grounelacasse.com

